

JVC

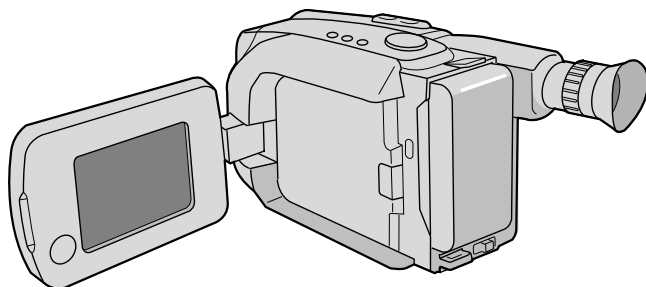

COMPACT VHS CAMCORDER

GR-AXM23



Compact VHS



INSTRUCTIONS



CONTENTS

GETTING STARTED	6
RECORDING	14
Basic Recording	14
Basic Features	18
Advanced Features	22
Programme AE With Special Effects	22
Fader	24
Wide	24
Super LoLux (Gain Up)	25
Instant Titles	25
Character Generator	26
Using Menu For Detailed Adjustment	27
Focusing	30
Exposure Control	32
Manual White Balance Adjustment	33
Self-Timer	34
Animation	35
Time Lapse	35
PLAYBACK	36
Basic Playback	36
Features	37
Using The Cassette Adapter	39
Basic Connections	40
TAPE DUBBING	41
USER MAINTENANCE	42
TROUBLESHOOTING	43
INDEX	45
LCD monitor/viewfinder	45
Controls	47
Connectors	47
Indicators	47
Other Parts	47
Terms	48
CAUTIONS	49
SPECIFICATIONS	51

Dear Customer,

Thank you for purchasing the JVC Compact VHS camcorder. Before use, please read the safety information and precautions contained in the following pages to ensure safe use of your new camcorder.

Using This Instruction Manual

- All major sections and subsections are listed in the Table Of Contents (☞ cover page).
- Notes appear after most subsections. Be sure to read these as well.
- Basic and advanced features/operation are separated for easier reference.

It is recommended that you . . .

- refer to the Index (☞ pg. 45 – 48) and familiarize yourself with button locations, etc. before use.
- read thoroughly the Safety Precautions that follow and cautions (☞ pg. 49, 50). They contain extremely important information regarding the safe use of your new camcorder.

SAFETY PRECAUTIONS

WARNING:
TO PREVENT FIRE OR SHOCK HAZARD, DO NOT EXPOSE THIS UNIT TO RAIN OR MOISTURE.

Warning on lithium battery

The battery used in this device may present a fire or chemical burn hazard if mistreated. Do not recharge, disassemble, heat above 100°C or incinerate.

Replace the battery with Panasonic (Matsushita Electric), Sanyo or Maxell CR2025; use of another battery may present a risk of fire or explosion.

- Dispose of used battery promptly.
- Keep away from children.
- Do not disassemble and do not dispose of in fire.

CAUTIONS:

- To prevent shock, do not open the cabinet. No user serviceable parts inside. Refer servicing to qualified personnel.
- When you are not using the AC Power Adapter/Battery charger for a long period of time, it is recommended that you disconnect the power cord from AC outlet.

NOTES:

- *The rating plate (serial number plate) and safety caution are on the bottom and/or the back of the main unit.*
- *The rating plate (serial number plate) of the AC Power Adapter/Charger is on its bottom.*

This unit is produced to comply with Standard IEC Publ. 65.

This camcorder is designed to be used with PAL-type colour television signals. It cannot be used for playback with a television of a different standard. However, live recording and viewfinder playback are possible anywhere. Use the BN-V12U/BN-V22U/BN-V25U battery packs and, to recharge them, the provided multi-voltage AC Power Adapter/Charger. (An appropriate conversion adapter may be necessary to accommodate different designs of AC outlets in different countries.)



- This camcorder is designed exclusively for the VHS-C video cassette. Only cassettes marked VHS-C can be used with this unit.
- HQ VHS is compatible with existing VHS equipment.

ATTENTION USERS OF RECHARGEABLE BATTERIES

DO NOT DISPOSE RECHARGEABLE BATTERIES OR PRODUCTS POWERED BY NON-REMOVABLE RECHARGEABLE BATTERIES, THESE BATTERIES AND PRODUCTS CAN BE RECYCLED.

AT THE END OF NORMAL LIFE,

IN AUSTRALIA, RETURN TO YOUR POINT OF PURCHASE OR MAIL TO:

Hagemeyer (Australasia) B.V. 5-7 Garema Circuit Kingsgrove NSW 2208 Australia

Attn : Service Dept.

Phone : (02)750 3777

IN NEW ZEALAND, PLEASE RETURN BATTERIES BY MAIL TO:

Hagemeyer (NZ) Limited P.O. Box 100589 Auckland 1000

Phone : (09)415 8758

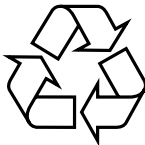

REMEMBER

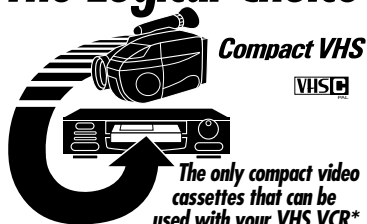
The Logical Choice

*The only compact video cassettes that can be used with your VHS VCR**

*with Cassette Adapter

Programme AE with Special Effects (☞ pg. 22)

- Auto Mode Lock
- Auto Mode Release
- Electronic Fog Filter
- ND Effect
- Sepia
- Twilight
- Sports
- 1/1000 sec. High Speed Shutter
- 1/2000 sec. High Speed Shutter

5Sec.-Rec (5 sec. Recording)
(☞ pg. 20)**22 x Optical Hyper Zoom**
(☞ pg. 18)

Zoom-in

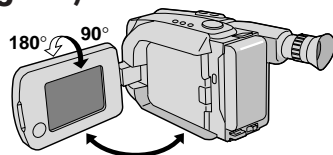

Zoom-out

LCD Colour Monitor
(☞ pg. 16)**Program Manager II**
(☞ pg. 22 - 35)

Programme AE with Special Effects, Fader, Wide, Super LoLux, Instant Titles, Menu Adjustment (Focus, Exposure Control and so on.)

PROVIDED ACCESSORIES

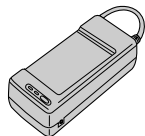

• AC Power Adapter/
Charger AA-V15EA

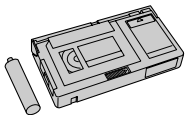

• Cassette Adapter
C-P7U

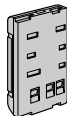

• Battery Pack
BN-V12U

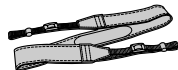

• Shoulder Strap



• Lithium Battery
CR2025 x 1 (for clock operation)



• DC Cord

SUPPLY POWER

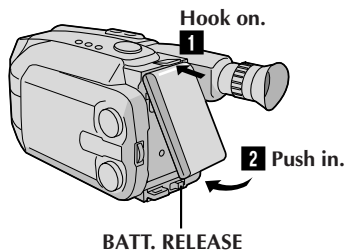

Using the battery pack

- 1** Hook-on the battery pack's top end to the camcorder. (Charging procedure, pg. 6)
- 2** Push in the battery pack until it locks into place.

To remove the battery pack

Slide **BATT. RELEASE** and pull out the battery pack.

INSERTING A VIDEO CASSETTE

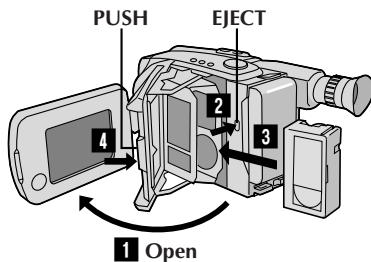

- 1** Open the LCD monitor to an angle of over 45 degrees.
- 2** Press **EJECT** to open the cassette holder.
- 3** Insert a video cassette.
- 4** Press **PUSH** to close the cassette holder. (For more details, pg. 11)

PLAYBACK

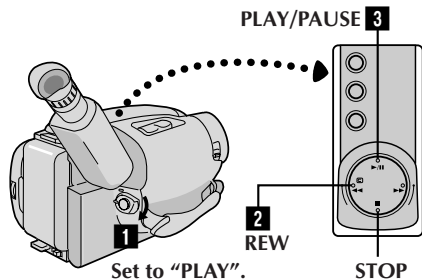

- 1** Set the Power Switch to "PLAY".
 - 2** Press **REW**.
— The tape will automatically stop at the beginning of the tape.
 - 3** Press **PLAY/PAUSE**.
— Playback starts and the playback picture appears.
- To stop playback, press **STOP**. (For more details, pg. 36.)
 - The viewfinder switches off automatically to save power when the LCD monitor is opened at an angle of over 45 degrees.
 - The LCD monitor turns on/off when it is opened/closed at approx. 45 degrees.

Or simply play back the tape on a VHS VCR using the Cassette Adapter. pg. 39

SHOOTING

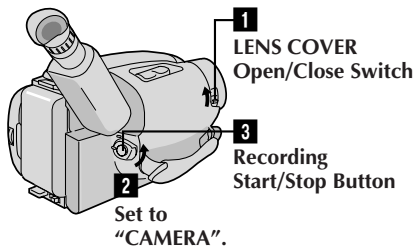

- 1** Slide the **LENS COVER** Open/Close Switch to open the lens cover.
 - 2** Set the Power Switch to "CAMERA".
— The power indicator will light and an image will appear.
 - 3** Press the Recording Start/Stop Button.
— Recording starts.
- To stop recording temporarily, momentarily press the Recording Start/Stop Button once again. (For more details, pgs. 14 – 17)
 - The viewfinder switches off automatically to save power when the LCD monitor is opened at an angle of over 45 degrees.
 - The LCD monitor turns on/off when it is opened/closed at approx. 45 degrees.

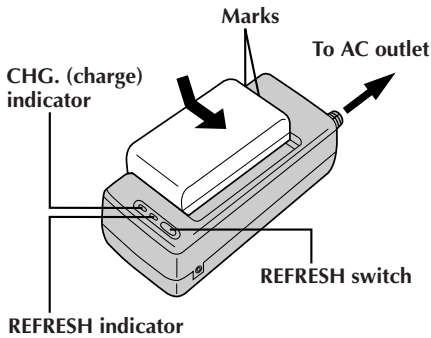
**REFRESH**

The AC power adapter features a REFRESH function that allows you to fully discharge the battery pack before recharging. Perform the REFRESH function after no less than 5 chargings.

To discharge the battery . . .

..... attach the battery pack to the adapter as shown in the above illustration. Then push REFRESH. The REFRESH indicator lights when discharging starts, and goes out when discharging is complete.

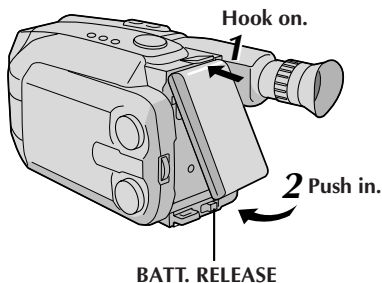
**ATTENTION:**

Before detaching the power source, make sure that the camcorder's power is turned off. Failure to do so can result in a camcorder malfunction.

Power

This camcorder's 3-way power supply system lets you choose the most appropriate source of power.

NOTES:

- No function is available without power supply.
- Use only specified power supply.
- Do not use provided power supply units with other equipment.

CHARGING THE BATTERY PACK**SUPPLY POWER**

- 1 Connect the charger's AC power cord to a wall outlet.

ATTACH BATTERY PACK

- 2 Align the marks and slide the battery pack in the direction of the arrow until it locks in place.

- The CHG. indicator begins blinking to indicate charging has started.

DETACH BATTERY PACK

- 3 When the CHG. indicator stops blinking but stays lit, charging is finished. Slide the battery pack opposite the direction of the arrow.

BATT. PACK	CHARGE	DISCHARGE
BN-V12U	approx. 1 hr. 10 min.	approx. 3 hrs. 30 min.
BN-V22U	approx. 2 hrs. 10 min.	approx. 7 hrs.
BN-V25U	approx. 2 hrs. 40 min.	approx. 10 hrs.

USING THE BATTERY PACK**ATTACH BATTERY PACK**

- 1 Hook its top end to the camcorder and push the battery pack in until it locks in place.

DETACH BATTERY PACK

- 2 Slide **BATT. RELEASE** and pull out the battery pack.

Approximate recording time (unit: min.)

BATT. PACK	LCD monitor on/ Viewfinder off	LCD monitor off/ Viewfinder on	LCD monitor on/ Viewfinder on
BN-V12U	60	60	50
BN-V22U	125	130	110
BN-V25U	165	170	145

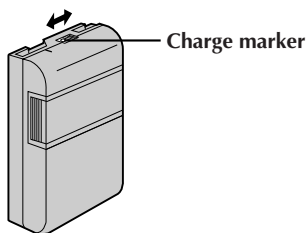

CHARGE MARKER

A charge marker is provided on the battery pack to help you remember whether it has been charged or not. Two colours are provided (red and black)—you choose which one means charged and which means discharged.

NOTES:

- The recording time per charge is affected by such factors as the time spent in Record-Standby mode and the frequency of zooming. It is safer to have spare battery packs.
- Charging times noted on page 6 are for fully discharged battery pack, and discharging times are for fully charged battery pack.
- Charging and discharging times vary according to the ambient temperature and the status of the battery pack.
- Remember to set the charge marker after charging a battery pack or after detaching a discharged one from your camcorder.
- Perform the REFRESH function after no less than 5 chargings.
- While the AC Power Adapter/Charger's power cord is disconnected from the AC outlet, it is possible to discharge the battery by pressing the REFRESH switch. During that time, the AC Power Adapter/Charger does not charge the battery. When discharging is complete, detach the battery from the AC Power Adapter/Charger to store it.
- High temperatures can damage the battery pack, so use only where good ventilation is available. Don't allow it to discharge in container, such as a bag.
- If you stop recharging or discharging part way through, make sure to remove the battery pack before unplugging the adapter's AC cord.
- Remove the battery pack from the adapter immediately after discharging.
- To avoid interference with reception, do not use the AC Power Adapter/Charger near a radio.
- Make sure you unplug the DC cord before charging or discharging the battery pack.
- The CHG. indicator may not light properly with a brand new battery pack, or with one that's been stored for an extended period. In this case, remove and reattach the battery pack and recharge it. The CHG. indicator should blink during recharging. If not, contact your nearest JVC dealer.

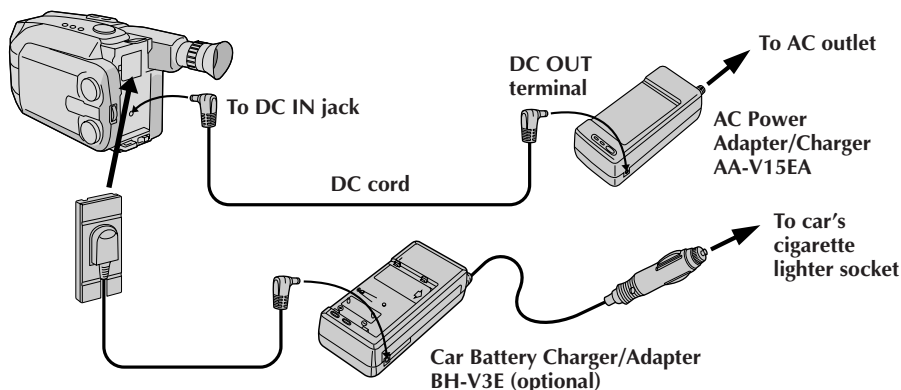

USING A CAR BATTERY

Use the optional Car Battery Charger/Adapter (connect as shown in the illustration above).

NOTES:

- When using the car battery, leave the engine idling.
- The optional Car Battery Charger (BH-V3E) can also be used to charge the battery pack.
- When using the optional Car Battery Charger, refer to the respective instruction booklet.

USING AC POWER

Use the AC Power Adapter (connect as shown in the illustration above).

NOTE:

The supplied AC Power Adapter/Charger features automatic voltage selection in the AC range from 110 V to 240 V.

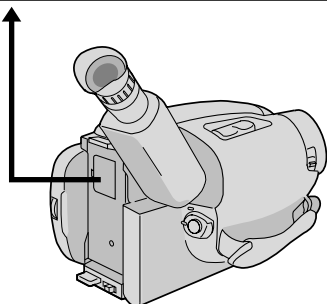
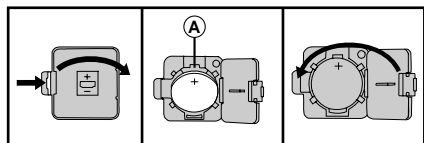

Clock (Lithium) Battery Insertion/Removal

This battery is necessary for clock operation and to perform date/time settings.

SWITCH OFF POWER

- 1 Switch off the unit's power and remove the power supply unit.

OPEN COVER

- 2 Open the clock battery compartment cover while pressing the release tab.

REMOVE BATTERY (when replacing)

- 3 Insert a pointed, non-metallic object between the battery and the compartment (A) and pull the battery out.

INSERT BATTERY

- 4 Ensure that the plus (+) side is up and insert a CR2025 lithium battery and push it in.

CLOSE COVER

- 5 Close the compartment cover until it clicks in place.

NOTE:

See "SAFETY PRECAUTIONS" (pg. 2) for information on safe handling of lithium batteries.

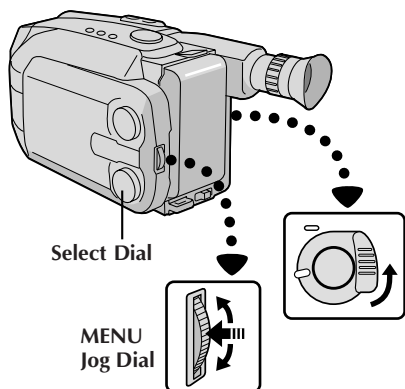

LCD monitor or viewfinder

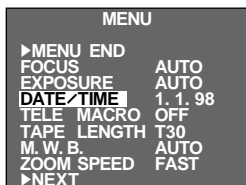

Menu Screen



DATE/TIME Setting Menu

24-hour indication

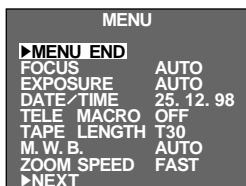

Date/Time Setting

ACCESS MENU SCREEN

- 1 First set the Power Switch to "CAMERA". Turn the Select Dial to any position except AUTO LOCK, then press the MENU Jog Dial.

SELECT FUNCTION

- 2 Rotate the MENU Jog Dial to move the highlight bar to "DATE/TIME", then press it. The DATE/TIME Setting Menu appears.

- If you decide you want to return the date and time to the previous settings, rotate the MENU Jog Dial to move highlight bar to "EXIT" and press it, then go to step 6.
- If you want to set only the time without changing the date, go to step 4.

SET DATE

- 3 Rotate the MENU Jog Dial to move the highlight bar to the item you want to set and then press it. When the setting begins blinking, rotate the MENU Jog Dial until the correct setting appears and then press it. The setting stops blinking.

- Repeat this procedure until you're satisfied with the Date settings ("YEAR", "MONTH" and "DAY").

SET TIME

- 4 Rotate the MENU Jog Dial to move the highlight bar to "TIME" and then press it. When the hour setting begins blinking, rotate the MENU Jog Dial until the correct setting appears and then press it. When the hour setting stops blinking and the minute setting begins blinking, rotate the MENU Jog Dial until the correct setting appears and then press it. The minute setting stops blinking.

START CLOCK OPERATION

- 5 When none of these settings (YEAR, MONTH, DAY, TIME) blinks, rotate the MENU Jog Dial to move the highlight bar to "EXIT", and press it. The Menu Screen appears and "MENU END" is highlighted.

CLOSE MENU

- 6 Press the MENU Jog Dial.

NOTE:

To display the date and time in the LCD monitor or the viewfinder and on a connected TV, see "Date/Time/Character Insert" (pg. 21).

LCD monitor or viewfinder

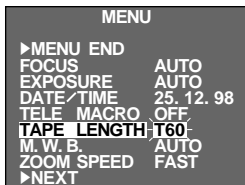

Menu Screen

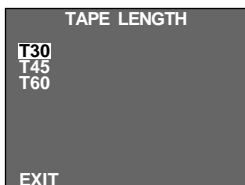

TAPE LENGTH Setting Menu

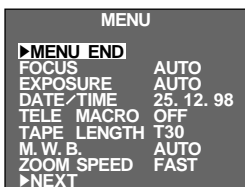

SP/LP Recording Mode Button

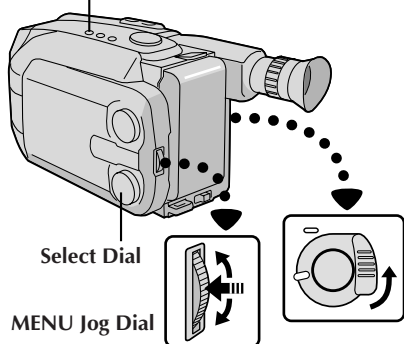

Select Dial

MENU Jog Dial

Viewfinder

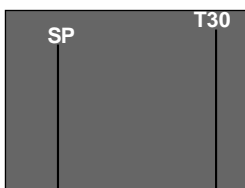
Recording mode
indicatorTape length
indicator

Tape Length Setting

Set the tape length according to the length of the tape used.

1 ACCESS MENU SCREEN

First set the Power Switch to "CAMERA". Turn the Select Dial to any position except AUTO LOCK, then press the MENU Jog Dial.

2 SELECT FUNCTION

Rotate the MENU Jog Dial to move the highlight bar to "TAPE LENGTH", then press it. The TAPE LENGTH Setting Menu appears.

3 SET TAPE LENGTH

Rotate the MENU Jog Dial to move the highlight bar to the correct setting. T30=30 minutes of recording time, T45=45 minutes, and T60=60 minutes (in SP).

- If you decide you want to return the tape length to the previous setting, rotate the MENU Jog Dial to move the highlight bar to "EXIT".

4 CLOSE MENU

Press the MENU Jog Dial. The Menu Screen reappears and the highlight bar is on "MENU END". Then press the MENU Jog Dial again to close the Menu Screen.

NOTES:

- The tape remaining time (pg. 15) displayed in the viewfinder is correct only if the correct tape length has been selected.
- Once you have set the tape length, it remains unchanged even if the Select Dial is returned to AUTO LOCK.

Recording Mode Setting

Set depending on your preference.

1 SET RECORDING MODE

First set the Power Switch to "CAMERA". Press SP/LP Button for more than 1 second. "SP" (Standard Play) provides higher picture and sound quality and is better for dubbing, while "LP" (Long Play) is more economical, providing twice the recording time.

NOTE:

If the recording mode is switched during recording, the playback picture will be blurred at the switching point.

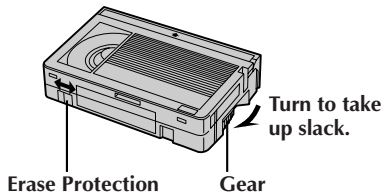
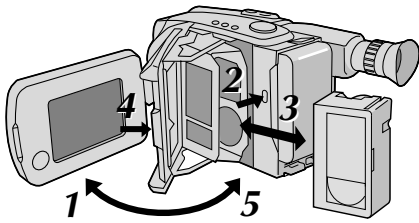

Loading/Unloading A Cassette

- 1 OPEN LCD MONITOR**
Open the LCD monitor to an angle of over 45 degrees.
- 2 OPEN CASSETTE HOLDER**
Press **EJECT** until the holder opens. Do not use force to open.
- 3 INSERT/REMOVE CASSETTE**
Make sure the label is facing outward.
- 4 CLOSE CASSETTE HOLDER**
Press **PUSH** and make sure the holder is closed and locked.
- 5 CLOSE LCD MONITOR**
First make sure the holder is closed. Then close the LCD monitor.

NOTES:

- Closing the LCD monitor while the cassette holder is still open may cause damage to the LCD monitor.
- A cassette holder can't be opened unless a power supply is attached.
- Make sure that the tape is not slack when loading the cassette. If there is any slack, turn the gear on the cassette in the direction of the arrow to take up the slack.
- Make sure the Erase Protection tab is in the position that allows recording. If not, slide the tab. Some cassettes have removable tabs. If the tab has been removed, cover the hole with adhesive tape.
- The cassette holder can't be opened while the camcorder is in the record mode.

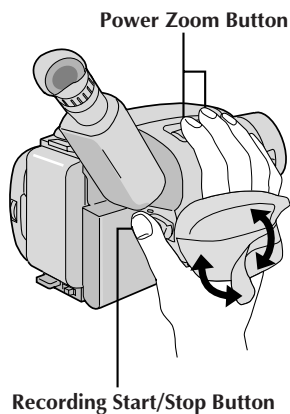

Grip Adjustment

EXPAND LOOP

- 1 Separate the Velcro strip.

INSERT HAND

- 2 Pass your right hand through the loop and grasp the grip.

ADJUST STRAP LENGTH

- 3 Adjust so your thumb and fingers can easily operate the Recording Start/Stop Button and Power Zoom Button. Refasten the Velcro strip.

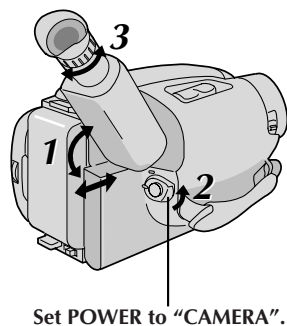

Viewfinder Adjustment

POSITION VIEWFINDER

- 1 Adjust the viewfinder manually for best viewability (see illustration to the left).

SELECT MODE

- 2 Set the Power Switch to CAMERA.

ADJUST DIOPTR

- 3 Turn the Dioptre Adjustment Control until the indications in the viewfinder are clearly focused.

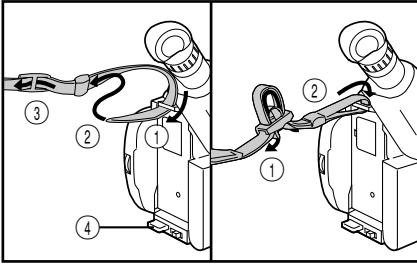

Shoulder Strap Attachment

ATTACH STRAP

- 1 Following the illustration at left, thread the strap through the top of the eyelet ①, then fold it back and thread it through the keeper ②, and then through the buckle ③. Repeat the procedure to attach the other end of the strap to the other eyelet ④, making sure the strap isn't twisted.

ADJUST LENGTH

- 2 Adjust as shown in the illustration at left ①, then slide both keepers snug against the eyelets to prevent slipping ②.

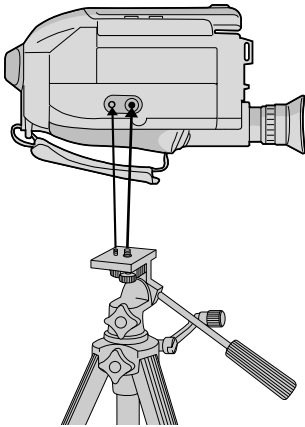

Tripod Mounting

ALIGN AND TIGHTEN

- 1 Align the screw and camera direction stud on the tripod with the camera's mounting socket and stud hole. Then tighten the screw.

CAUTION:

When using a tripod, be sure to open and extend its legs fully to stabilize the camcorder. To prevent damage to the unit caused by falling over, do not use a small-sized tripod.

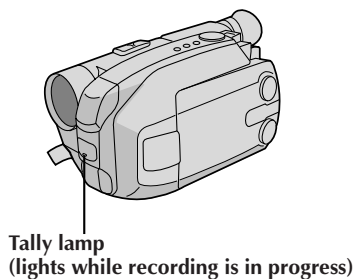
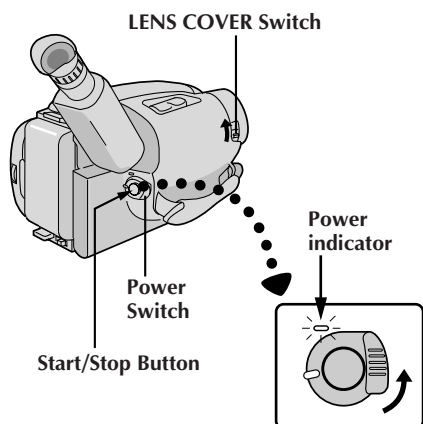
**NOTE:**

You should already have performed the procedures listed below. If not, do so before continuing.

- Power (☞ pg. 6)
- Tape Length Setting (☞ pg. 10)
- Recording Mode Setting (☞ pg. 10)
- Grip Adjustment (☞ pg. 12)

LOAD A CASSETTE

- 1 First open the LCD monitor to an angle of over 45 degrees. Press **EJECT** to open the cassette holder, then insert the cassette with the label facing out. Press **PUSH** to ensure the holder is closed and locked.

Shooting while watching the viewfinder**ENTER RECORD-STANDBY MODE**

- 2 Make sure the LCD monitor is closed and locked. Slide the **LENS COVER** Open/Close Switch to open the lens cover, then set the Power Switch to **CAMERA**.

- The power indicator lights and the camcorder enters the Record-Standby mode.
- The scene you're aimed at appears on the viewfinder screen, with the word "PAUSE" superimposed upon it.

START SHOOTING

- 3 Press the Recording Start/Stop Button.

- **REC** appears in the viewfinder while recording is in progress.

Tape remaining time indicator

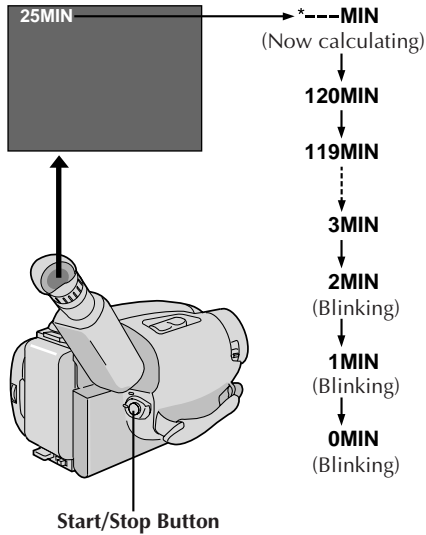

STOP RECORDING

4 Press the Recording Start/Stop Button again to stop recording.

- The camcorder re-enters the Record-Standby mode.

NOTES:

- When the Power Switch is set to CAMERA and the LCD monitor is opened at an angle of 45 degrees or more, the LCD monitor switches on and the viewfinder switches off automatically to save power.
- A cassette holder can't be opened unless a power supply is attached.
- There may be a delay after you press EJECT until the holder opens. Do not use force.
- The tape remaining time is only displayed in the viewfinder as shown.
- The remaining time indicated in the viewfinder is approximate.
- The time required to calculate the remaining tape length, and the accuracy of the calculation, may vary according to the type of tape used.
- The tape remaining time indicator is correct only if the correct tape length has been selected (☞ pg. 10).
- "TAPE END" appears when the tape reaches its end, and the power goes off automatically if left in this condition for 5 minutes. "TAPE END" also appears when a cassette whose tape is already at its end is loaded.
- If the Record-Standby mode continues for 5 minutes without performing Zoom or any other operations, the camcorder's power shuts off automatically. Set the Power Switch to "POWER OFF", and then back to "CAMERA" to turn the camcorder on again.
- If the Recording Start/Stop Button is pressed after the Record-Standby mode has continued for over 5 minutes, recording may not start immediately.
- If you're recording on a cassette from the middle (such as when a tape is removed and re-inserted during recording), use the Retake function (☞ pg. 19) to find the end of the last recording so you don't erase any of it.
- The LENS COVER warning blinks for about 5 seconds when the camcorder is turned on when the cover is closed.
- While shooting, sound is not heard from the speaker.

Shooting while watching the LCD monitor

Before the following steps, perform step 1 (☞ pg. 14).

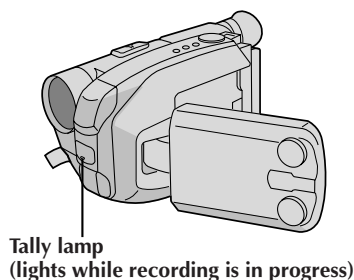
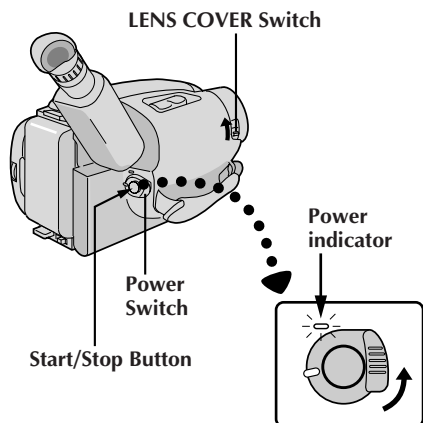
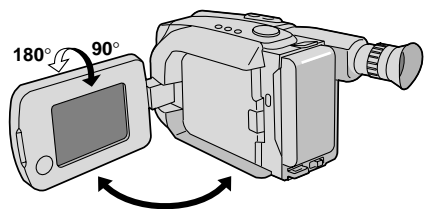

2 ENTER RECORD-STANDBY MODE

Make sure the LCD monitor is fully open. Slide the **LENS COVER Open/Close Switch** to open the lens cover, then set the Power Switch to CAMERA.

- The power indicator lights and the camcorder enters the Record-Standby mode.
- The scene you're aimed at appears in the LCD monitor, with the word "PAUSE" superimposed upon it.

3 START SHOOTING

Tilt the LCD monitor upward/downward for best viewability (☞ pg. 17) and press the Recording Start/Stop button.

- "REC" appears in the LCD monitor while recording is in progress.

4 STOP RECORDING

Press the Recording Start/Stop Button again to stop recording.

- The camcorder re-enters the Record-Standby mode.

NOTES:

- When you use the LCD monitor outdoors in direct sunlight, the LCD monitor may be difficult to see. If this happens, we recommend that you use the viewfinder (☞ pg. 14).
- The tape remaining time is not displayed on the LCD monitor. However, when the tape is about to reach its end, the following indicators appear: "2MIN" → "1MIN" → "0MIN".
- For other notes, refer to pg. 15.



Journalistic shooting

In some situations different angles of shooting may be required for more dramatic results.

1 OPEN LCD MONITOR

Make sure the LCD monitor is fully open.

2 TILT LCD MONITOR

Tilt the LCD monitor in the most convenient direction.

- The LCD monitor can rotate almost full circle (270°: 90° downward, 180° upward).

Interface shooting

A person you shoot can view himself/herself in the LCD monitor, and you can even shoot yourself while viewing your own image in the LCD monitor.

1 TILT LCD MONITOR UPWARD

Open the LCD monitor and tilt it upward to 180 degrees so that it faces forward.

- When the LCD monitor is tilted upward to an angle of over approx. 105 degrees, the monitor image is inverted vertically, and the viewfinder also switches on.

2 START RECORDING

Point the lens toward the subject (yourself when self-recording) and start recording.

- During Interface Shooting, the monitor image and indications do not appear inverted as they would when viewing a mirror.



Self-recording

NOTE:

During Interface Shooting, indications other than the Date/Time display and Title display do not appear in the viewfinder.

Brightness control

You can adjust the brightness of the LCD monitor by turning the **BRIGHT** Dial.

1 ADJUST BRIGHTNESS

If you want to brighten the image . . .
Turn the Dial towards "+".

If you want to darken the image . . .
Turn the Dial towards "-".

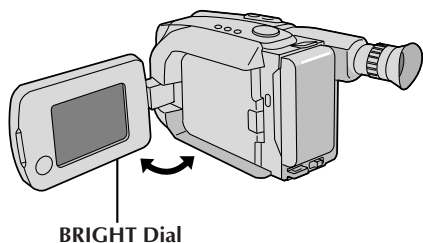

BRIGHT Dial

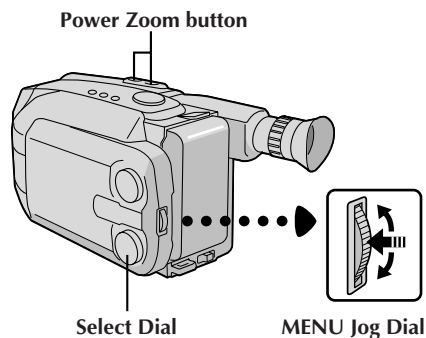
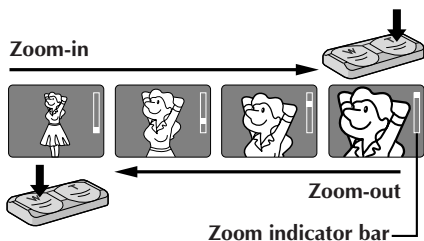

LCD monitor or viewfinder

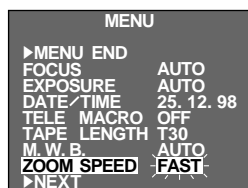

Menu Screen

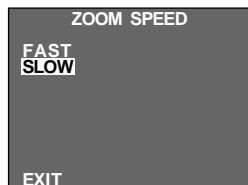

ZOOM SPEED Setting Menu

FEATURE:
PURPOSE:**OPERATION:****Zooming**

To produce the zoom in/out effect, or an instantaneous change in image magnification.

Zoom In

Press the "T" of the Power Zoom Button.

Zoom Out

Press "W" of the Power Zoom Button.

■ Zooming speed is available. A total of 4 zoom speeds are available. 2 speeds can be selected depending on how hard the Power Zoom Button is pressed (press the button fully for regular-speed, press it lightly for slow-speed), while 2 speed levels (FAST/SLOW) can be selected in the ZOOM SPEED Menu depending on the overall speed you prefer.

The combinations of zoom speeds are shown in the chart below.

Changing the ZOOM SPEED in the Menu

- 1) Set the Select Dial to any position except AUTO LOCK and press the MENU Jog Dial. The Menu Screen appears.
- 2) Rotate the MENU Jog Dial to move the highlight bar to "ZOOM SPEED", then press it. The ZOOM SPEED Setting Menu appears.
- 3) Rotate the MENU Jog Dial to move the highlight bar to the desired speed and press it twice. The Menu Screen disappears and setting is completed.

NOTE:

Focusing may become unstable during Zooming. In this case, set the zoom while in Record-Standby, lock the focus by using the manual focus (pg. 31), then zoom in or out in Record mode.

Zooming Speed (1 – 4 in order of speed)

"ZOOM SPEED" in the Menu Screen	Pressing the Power Zoom Button	
	fully	lightly
FAST	1 (fastest)	3
SLOW	2	4 (slowest)

☐ : when the Select Dial is set to AUTO LOCK.

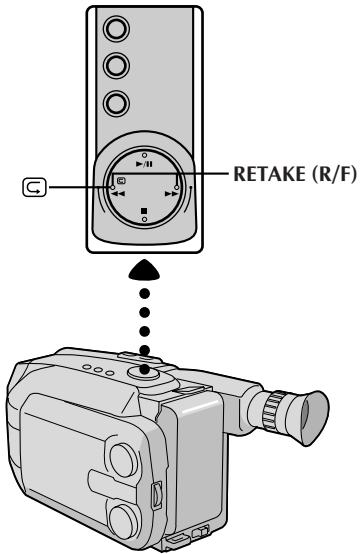

<p>FEATURE:</p> <p>PURPOSE:</p> <p>OPERATION:</p> <p>NOTE:</p>	<p>Quick Review</p> <p>To check the end of the last recording.</p> <p>1) Press “C” and release quickly during the Record–Standby mode.</p> <ul style="list-style-type: none"> ■ Tape is rewound for about 2 seconds and played back automatically, then pauses in Record–Standby mode for the next shot. <p><i>Distortion may occur at start of playback. This is normal.</i></p>
<p>FEATURE:</p> <p>PURPOSE:</p> <p>OPERATION:</p> <p>NOTE:</p>	<p>Retake</p> <p>To re-record certain segments.</p> <p>1) Make sure the camcorder is in the Record–Standby mode.</p> <p>2) Press either RETAKE button to reach the start point for new recording. Pressing “F” forwards the tape and pressing “R” reverses it.</p> <p>3) Press Recording Start/Stop Button to start recording.</p> <p><i>Noise may appear during Retake. This is normal.</i></p>

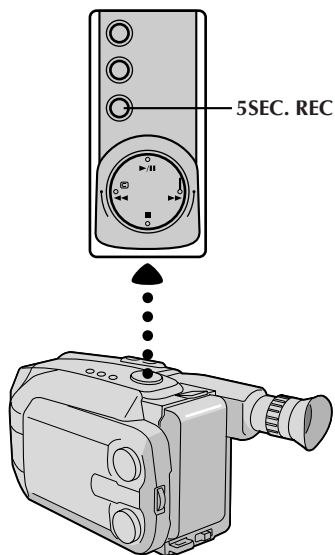
**FEATURE:****PURPOSE:****OPERATION:****NOTE:****5Sec. Rec (5-sec. Recording)**

To record a scene for 5 seconds, providing quick scene transitions like those seen in TV programmes.

- 1) During Record-Standby, press **5SEC. REC.** "5S" appears and 5Sec. Rec is reserved.
- 2) Press Recording Start/Stop Button. Recording starts, and after 5-second recording is finished, the camcorder reenters the Record-Standby mode automatically.
 - To cancel the 5Sec. Rec. function, press **5SEC. REC** again so that "5S" disappears.

*The Fader (pg. 24) cannot be activated by pressing **5SEC. REC.***

LCD monitor or viewfinder

5Sec. Rec mode indicator

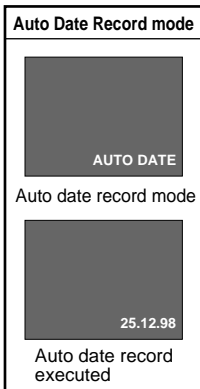
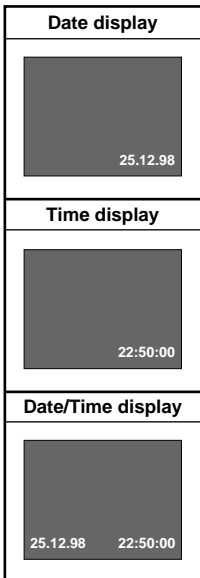
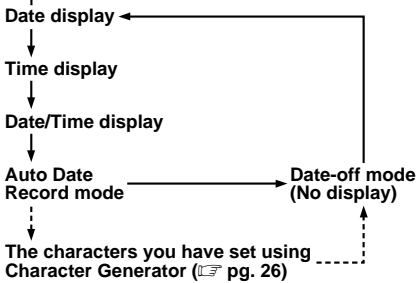
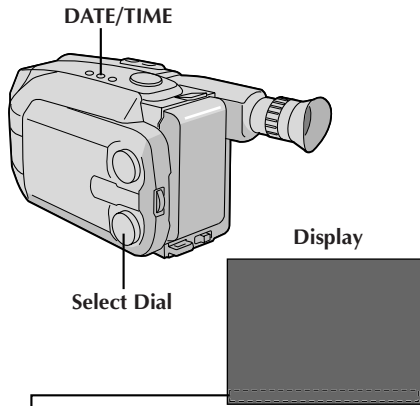

FEATURE:
PURPOSE:

OPERATION:

NOTES:

Date/Time/Character Insert

To display the date and time on the LCD monitor, in the viewfinder, or on a connected colour monitor, as well as to record them manually or automatically.

- 1)** Turn the Select Dial to any position except AUTO LOCK.
2) Choose a display mode by pressing **DATE/TIME** repeatedly while in Record-Standby to cycle through the modes as shown in the illustration to the left.
- You should have already performed the Date/Time Setting procedure (pg. 9). If you haven't, do so first.

DISPLAY

- The selected display can be recorded.
- If you don't want to record the display, select the Date-off mode before shooting.
- If you want to delete the display during shooting, press **DATE/TIME**.
- To recall the display, engage the Record-Standby mode and press **DATE/TIME** repeatedly until the desired display appears.

AUTO DATE RECORD

- Your camcorder automatically records the date for about 5 seconds after recording is initiated in the following situations:
 - After changing the date.
 - After loading a cassette.
 - After Auto Date Record mode is selected by pressing **DATE/TIME**.
 In this mode, the date is replaced after 5 seconds with "AUTO DATE" but this is not recorded.
- Setting the Select Dial to AUTO LOCK always engages the Auto Date Record mode, and disables all other modes.

1 second later, the mode is activated.



LCD monitor or
viewfinder

After 1 sec.

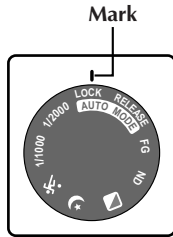
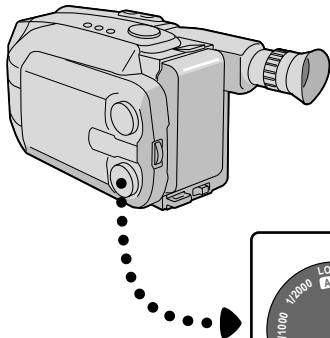
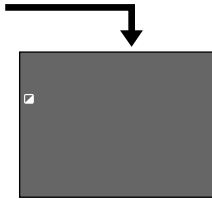

Select Dial

Programme AE With Special Effects

All you have to do to access any of the variety of shooting effects is to turn the Select Dial.

SELECT MODE

1 Turn the Select Dial until the symbol of the function you want is aligned with the mark.

- The selected mode's name and its indication are displayed for approx. 1 second. Then the name disappears, and only the indication remains. The mode is activated.
- When Auto Mode Lock or Auto Mode Release mode is selected, only the mode's name is displayed. Then the name disappears and the mode is activated.

NOTES:

- Only one effect can be engaged at a time.
- The screen becomes slightly reddish when the Fader (pg. 24) is used in the Sepia mode.
- The screen becomes slightly dark in the High Speed Shutter mode. Use in well-lit situations.
- In the High Speed Shutter or Sports modes, picture colour may be adversely affected if subject is lit by alternating discharge-type light sources such as fluorescent or mercury-vapour lights.

Dial symbol	LCD monitor/ Viewfinder indication	Mode
LOCK	AUTO LOCK	Auto Mode Lock

Auto Mode Lock

Locks the camcorder in Full Auto mode, preventing incorrect operation due to accidental button pressing during shooting.

- In this mode the following controls are disabled; DATE/TIME display select, and the Menu Jog Dial.

RELEASE	AUTO RELEASE	Auto Mode Release
---------	--------------	-------------------

Auto Mode Release

Re-enables the controls that were disabled by Auto Mode Lock.

FG	FG : FOG	Electronic Fog Filter
----	----------	-----------------------

Electronic Fog Filter

Makes the picture look misty white, as when an external fog filter is attached to the lens. Softens the image and gives it a “fantasy” look.

ND	ND:ND EFFECT	ND Effect
----	--------------	-----------



ND Effect

A black mist darkens the picture, as when an ND filter is used. Helps to counter the effects of glare on the subject.

	SEPIA	Sepia
--	-------	-------

Sepia

The scene being shot is recorded in sepia-tinted (reddish-brown) monochrome, giving the effect of an older movie. Use together with Wide (pg. 24) for the authentic look of a classic Hollywood movie.

Dial symbol	LCD monitor/ Viewfinder indication	Mode
	 TWILIGHT	Twilight

Twilight

Dusk, twilight scenery, fireworks, etc., look more natural and dramatic. The following happens when Twilight mode is selected:

- Auto gain control is turned off.
- White Balance is set to “☀️” (FINE day mode), but can also be manually changed to another mode (pg. 33).
- Auto Focus becomes available only in the range of 10 m to infinity. To focus when the subject-to-camera distance is less than 10 m, use manual focusing (pg. 31).

	 SPORTS	Sports
---	--	--------

Sports

High shutter speed clearly captures fast-moving action.

1/1000	 1 S 1/1000	1/1000 sec. High Speed Shutter
--------	--	-----------------------------------

1/2000	 2 S 1/2000	1/2000 sec. High Speed Shutter
--------	--	-----------------------------------

High-Speed Shutter (1/1000s., 1/2000s.)

Captures faster action than Sports mode.

Fade-in



Fade-out

LCD monitor or viewfinder

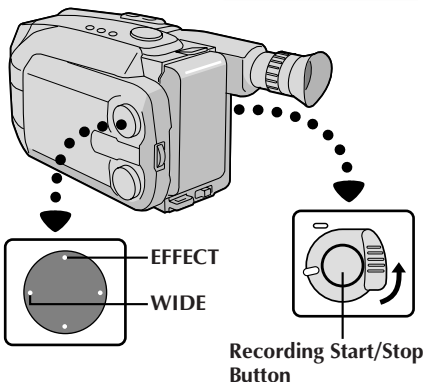
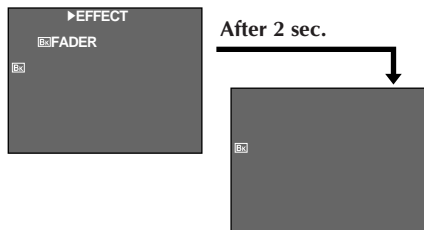

Recording Start/Stop Button

LCD monitor or viewfinder

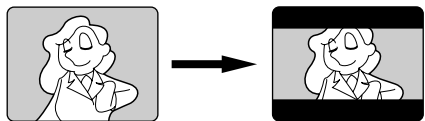

Wide mode

Fader

This feature allows smooth fade-in and fade-out to black blank screen. Fade-in works at recording start, and fade-out works at recording end or when you enter Record-Standby mode.

1 ENGAGE FADE-STANDBY MODE

Press **EFFECT** to engage the Fade-Standby mode.

- "FADER" is displayed for approx. 2 seconds. Then "FADER" disappears, and only "F" remains.

2 START OR END RECORDING

Press Recording Start/Stop Button to activate fade-in or fade-out.

3 TO CANCEL FADE-STANDBY MODE

While "F" is displayed, press **EFFECT**.

- "OFF" is displayed for approx. 2 seconds and the fade-standby mode is cancelled.

NOTES:

- Pressing and holding the Recording Start/Stop Button allows you to record a black blank screen.
- The screen becomes slightly reddish when the Fader is used with Sepia (pg. 23).
- With the Electronic fog filter mode (pg. 23) engaged, the image fades in/out to a white screen.

Wide

This feature allows you to record black bars at the top and bottom of the screen to produce a cinema-like "wide-screen" effect.

1 ENGAGE WIDE MODE

Press **WIDE**.

- To restore normal screen, press **WIDE** again.

NOTE (for Fader, Wide, Super LoLux, and Instant Titles) :

When the Select Dial is turned to **AUTO LOCK**, the above functions will be set to the Factory settings (Fade-standby : "OFF", Wide mode : off, Super LoLux : "MAX", Instant Titles : off). Then when the Select Dial is returned to any position except **AUTO LOCK**, the above functions return to the settings you selected before turning it to **AUTO LOCK**. However, if the function is switched during **AUTO LOCK**, the selected mode will be set and will remain unchanged even when the Select Dial is turned to any position except **AUTO LOCK**.

LCD monitor or viewfinder

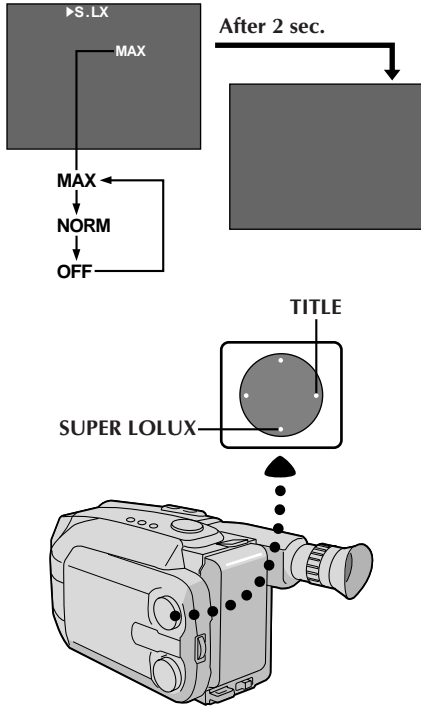

Super LoLux (Gain Up)

Bright, natural recordings can be taken even in areas with low or poor lighting.

1 SELECT SUPER LOLUX MODE

Press **SUPER LOLUX** repeatedly to cycle through the modes as shown to the left. Once the desired mode appears, it is engaged.

- The mode's name is displayed for approx. 2 seconds, then disappears.

MAX : To record a subject in a dark lit environment. When it is more convenient to shoot the subject with a brighter image even if the picture becomes slightly coarse.

NORM : To record a subject in a dimly lit environment. When it is more convenient to shoot with a less coarse picture although the subject becomes slightly dark.

OFF : Allows you to shoot dark scenes with no picture brightness adjustment.

LCD monitor or viewfinder

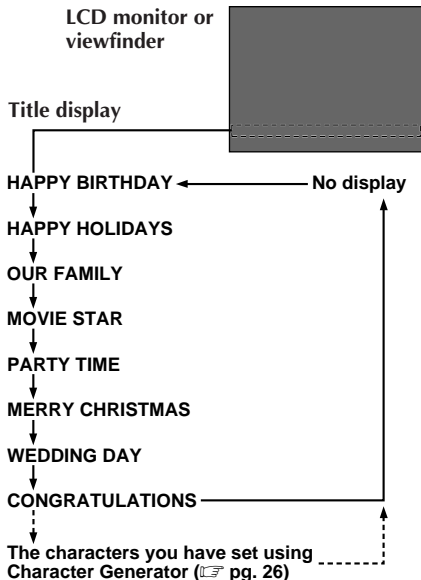

Instant Titles

The camcorder has eight preset titles in memory. You can superimpose one of them above a previously stored title as shown in the illustration to the left.

1 SELECT PRESET TITLE

Press **TITLE** repeatedly to cycle through the preset titles until the desired title is displayed.

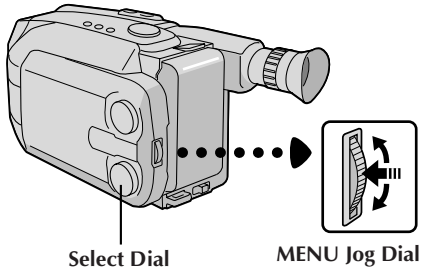

LCD monitor or viewfinder

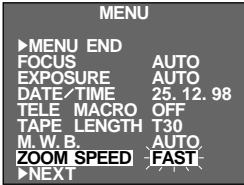

Menu Screen

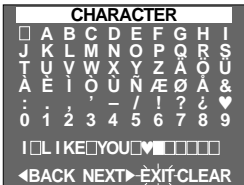
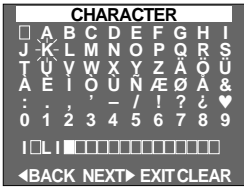
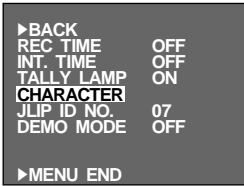

Character Generator

You can enter an original title of up to 18 characters.

- 1 **ACCESS MENU SCREEN**
Turn the Select Dial to any position except AUTO LOCK, then press the MENU Jog Dial. The Menu Screen appears.
- 2 **ACCESS CHARACTER MENU**
Rotate the MENU Jog Dial to move the highlight bar to "CHARACTER", then press it.
- 3 **INPUT CHARACTERS**
Rotate the MENU Jog Dial to make the desired character blink, then press it. The selected character appears at the bottom of the screen. Repeat for additional characters (max. 18).
 - To select the location of the next character, rotate the MENU Jog Dial to make "◀BACK" or "NEXT▶" at the bottom of the screen blink, then press it repeatedly to move the blinking cursor underneath the desired location. Rotate the MENU Jog Dial when you are done, and the blinking cursor returns to the character grid.
- 4 **END CHARACTER SETTING**
Rotate the MENU jog dial to make "EXIT" blink, then press it. The Menu Screen reappears and the highlight bar is placed on "MENU END".
- 5 **CLOSE MENU**
Press the MENU Jog Dial.

NOTES:

- To erase a character you entered mistakenly, make "CLEAR" blink by rotating the MENU Jog Dial, then press it. All characters are deleted at once. Or, to erase selected characters only, first move the blinking cursor to the characters at the bottom row which you want to replace, then rotate the MENU Jog Dial to highlight "□" in the top left corner, and then press it.
- To display the characters you have set — "Date/Time/Character Insert" (pg. 21) or "Instant Titles" (pg. 25).
- Characters may be set only in the Record-Standby mode.

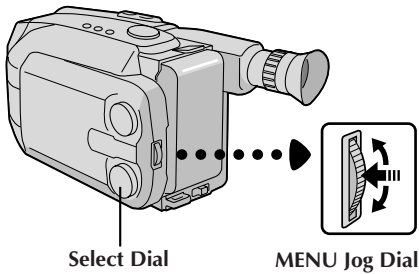

LCD monitor or viewfinder

MENU	
▶MENU END	AUTO
▶FOCUS	AUTO
EXPOSURE	25. 12. 98
DATE/TIME	OFF
TELE MACRO	T30
TAPE LENGTH	AUTO
M. W. B.	FAST
ZOOM SPEED	
▶NEXT	

Menu Screen 1



▶BACK	
▶REC TIME	OFF
INT. TIME	ON
TALLY LAMP	07
CHARACTER	OFF
JLIP ID NO.	
DEMO MODE	
▶MENU END	

Menu Screen 2



REC TIME	
OFF	
1/4 S	
1/2 S	
1 S	
5 S	
EXIT	

Setting Menu
(ex. REC TIME)



▶BACK	
▶REC TIME	1S
INT. TIME	OFF
TALLY LAMP	ON
CHARACTER	07
JLIP ID NO.	OFF
DEMO MODE	
▶MENU END	

Normal Screen

Using Menu For Detailed Adjustment

This camcorder is equipped with an easy-to-use, on-screen menu system that simplifies many of the more detailed camcorder settings.

1 ACCESS MENU SCREEN

Turn the Select Dial to any position except AUTO LOCK, then press the MENU Jog Dial. The Menu Screen appears.

2 SELECT FUNCTION

Rotate the MENU Jog Dial to place the highlight bar on the desired function.

- When the highlight bar reaches the bottom of Menu Screen 1, Menu Screen 2 is automatically displayed. When the highlight bar reaches the top of Menu Screen 2, Menu Screen 1 is automatically displayed.
- If the setting you want can't be found in the Menu Screen, place the highlight bar on "MENU END", then go to step 5.

3 MAKE SETTING

Press the MENU Jog Dial. The setting menu of the selected function appears. The setting procedure depends on the function you select.

If you select "FOCUS", "EXPOSURE", "DATE/TIME", or "CHARACTER" . . .

... see respective pages (FOCUS: [pg. 30, 31](#), EXPOSURE: [pg. 32](#), DATE/TIME: [pg. 9](#), CHARACTER: [pg. 26](#)).

If you select "JLIP ID NO." . . .

... press the MENU Jog Dial so that the number blinks, then rotate it until the desired number appears, and press it. Then rotate the MENU Jog Dial to move the highlight bar to "EXIT".

If you select any other functions . . .

... rotate the MENU Jog Dial to move the highlight bar to the desired setting.

- If you decide you want to return to the previous setting, rotate the MENU Jog Dial to move the highlight bar to "EXIT".

4 END SETTING

Press the MENU Jog Dial. The Menu Screen reappears and the highlight bar is on "MENU END".



5 CLOSE MENU

Press the MENU Jog Dial. The normal screen reappears.

NOTE:

The menu function except "FOCUS" and "EXPOSURE" are not available while in the Record mode.

Menu Screen Explanations

FOCUS	AUTO	Adjusts focus automatically.
	MANU	Allows you to adjust focus manually (☞ pg. 30, 31).
EXPOSURE	AUTO	Adjusts exposure automatically.
	MANU	Allows you to adjust exposure manually (☞ pg. 32).
DATE/TIME	Allows you to set the current date and time (☞ pg. 9).	
TELE MACRO	OFF	Usually the distance to a subject where the lens is in focus depends on the zoom magnification. Unless there is a distance more than 1 m to the subject, the lens is out of focus at the maximum telephoto setting. When set to "ON", you can shoot a subject as large as possible at a distance of approx. 60 cm. • Depending on the zoom position, the lens may go out of focus.
	ON	
TAPE LENGTH	Allows you to set the tape length depending on the tape used (☞ pg. 10).	
M.W.B.	AUTO	This camcorder's Automatic Colour Temperature system senses the colour temperature of the ambient lighting for automatic white balance adjustment. However, precise colour adjustment is not possible under the following conditions: • When an object is in various shades of the same colour. • When a predominantly red or brown object is being shot outdoors. In these cases, use the camcorder's built-in preset filters for white balance adjustment (☞ pg. 33).
	 : FINE	
	 : CLOUD	
	 : HALOGEN	
	MWB	
ZOOM SPEED	FAST	Allows you to set the zooming speed (☞ pg. 18).
	SLOW	

REC TIME	This feature allows you to set the parameters for Animation and Time-Lapse recording (☞ pg. 35).	
INT. TIME	This feature allows you to set the parameters for Self-Timer (☞ pg. 34) and Time-Lapse recording (☞ pg. 35).	
TALLY LAMP	ON	The tally lamp comes on to signal the start of recording.
	OFF	The tally lamp remains off at all times.
CHARACTER	Allows you to enter an original title of up to 18 characters (☞ pg. 26).	
JLIP ID NO.	This number is necessary when connecting the camcorder to a device such as a computer using the J terminal (JLIP). The numbers range from 01 to 99. Factory setting is 07.	
DEMO MODE	OFF	Automatic demonstration will not take place.
	ON	<p>Demonstrates certain functions such as the Fader, Instant Titles etc. When "DEMO MODE" is set to "ON" and the Menu Screen is closed, demonstration starts.</p> <p>NOTES:</p> <ul style="list-style-type: none"> ● When a tape whose Erase Protection tab is in the position that allows recording is loaded in the camcorder, demonstration is not available. ● By turning off the camcorder or inserting a tape whose Erase Protection tab is in the position that allows recording into it, "DEMO MODE" is set to "OFF" automatically. ● During demonstration, all functions except zoom are disabled.

 = Factory setting and when the Select Dial is set to AUTO LOCK



Focus
detection zone

Focusing

Auto Focus

The camcorder's Full Range AF system offers continuous shooting ability from close-up to infinity. However, correct focus may not be obtainable in the situations listed below (in these cases use manual focusing):

- When two subjects overlap in the same scene.
- When illumination is low.*
- When the subject has no contrast (difference in brightness and darkness), such as a flat, one-colour wall, or a clear, blue sky.*
- When a dark object is barely visible in the viewfinder.*
- When the scene contains minute patterns or identical patterns that are regularly repeated.
- When the scene is affected by sunbeams or light reflecting off the surface of a body of water.
- When shooting a scene with a high-contrast background.

* The low-contrast warning “▲▲” appears.

NOTES:

- If the lens is smeared or blurred, accurate focusing is not possible. Keep the lens clean, wiping with a piece of soft cloth if it gets dirty. When condensation occurs, wipe with a soft cloth or wait for it to dry naturally.
- When shooting a subject close to the lens, zoom-out first (☞ pg. 18). If zoomed-in in the auto focus mode, the camcorder could automatically zoom out depending on the distance between the camcorder and the subject. When Tele Macro (☞ pg. 28) is activated, the camcorder will not zoom out automatically.

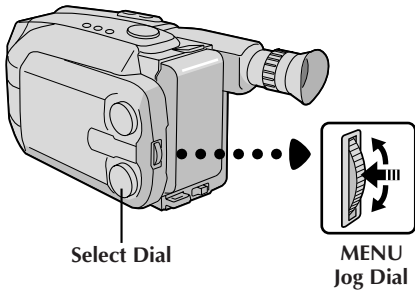

LCD monitor or viewfinder

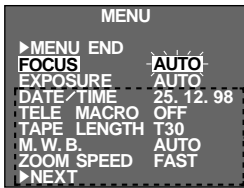

Menu Screen

No indication during recording

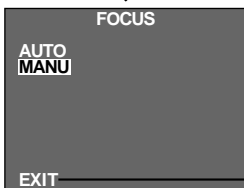

Focus Menu Screen

No indication during recording

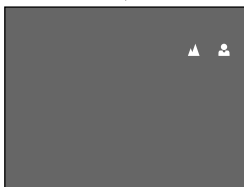

Manual Focus Screen

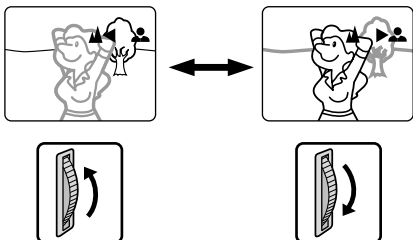

Manual Focus

NOTE:

You should already have made the necessary viewfinder adjustments (☞ pg. 12). If you haven't, do so before continuing.

1 ACCESS MENU SCREEN

Turn the Select Dial to any position except AUTO LOCK, then press the MENU Jog Dial. The Menu Screen appears, and the highlight bar is placed on "FOCUS".

2 ACCESS FOCUS MENU SCREEN

Press the MENU Jog Dial.

3 ACCESS MANUAL FOCUS

Rotate the MENU Jog Dial to move the highlight bar to "MANU", then press it. "▲" and "●" appear. The focus is locked at this point.

4 ADJUST FOCUS

To farther subject . . .

Rotate the MENU Jog Dial upward. "◀" appears and blinks.

Go to step 5.

To nearer subject . . .

Rotate the MENU Jog Dial downward. "▶" appears and blinks.

Go to step 5.

5 END ADJUSTMENT OF FOCUS

Press the MENU Jog Dial. The Menu Screen reappears and the highlight bar is placed on "MENU END".

6 CLOSE MENU

Press the MENU Jog Dial. The Menu Screen disappears and "▲●" reappears to indicate the focus is locked.

NOTES:

- To return to Auto Focus, select "AUTO" in step 3.
- To re-adjust Manual Focus, repeat the procedure from step 1.
- Be sure to focus the lens in the maximum telephoto position when you use the Manual Focus mode. If you focus in on a certain subject in the wide-angle position, sharply focused images cannot be obtained when zoomed up because the depth-of-field is reduced at longer focal lengths.
- When the focus level cannot be adjusted any farther or closer, "▲" or "●" will blink.

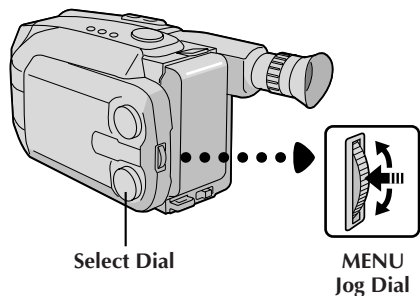

LCD monitor or viewfinder

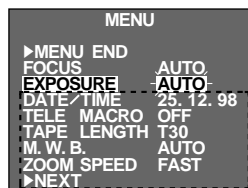

Menu Screen

No indication during recording

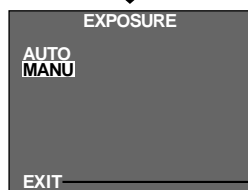

Exposure Menu Screen

No indication during recording

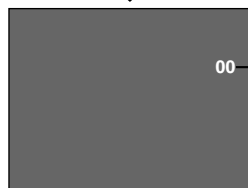

Manual Exposure Screen

Exposure control level counter

To brighten the image



To darken the image

Exposure Control

This feature automatically adjusts the iris for the best available picture quality, but you can override and make the adjustment manually.

- 1 **ACCESS MENU SCREEN**
Turn the Select Dial to any position except AUTO LOCK, then press the MENU Jog Dial. The Menu Screen appears.
- 2 **ACCESS EXPOSURE MENU SCREEN**
Rotate the MENU Jog Dial to move the highlight bar to "EXPOSURE" and press it.
- 3 **ACCESS MANUAL EXPOSURE**
Rotate the MENU Jog Dial to move the highlight bar to "MANU", then press it. "00" (exposure control level counter) appears.
- 4 **ADJUST EXPOSURE**
To brighten the image . . .
Rotate the MENU Jog Dial upward. The exposure control level counter increases (maximum +06). Go to step 5.
To darken the image . . .
Rotate the MENU Jog Dial downward. The exposure control level counter decreases (maximum -06). Go to step 5.
- 5 **END ADJUSTMENT OF EXPOSURE**
Press the MENU Jog Dial. The Menu Screen reappears and the highlight bar is placed on "MENU END".
- 6 **CLOSE MENU**
Press the MENU Jog Dial. The Menu Screen disappears and the exposure control level counter reappears to indicate the exposure is adjusted.

NOTES:

- To return to the factory setting, select "AUTO" in step 3.
- To re-adjust exposure, repeat the procedure from step 1.

LCD monitor or viewfinder

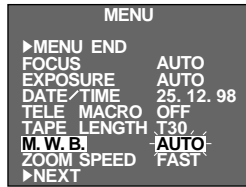

Menu Screen

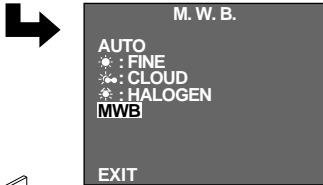

M.W.B. Menu Screen

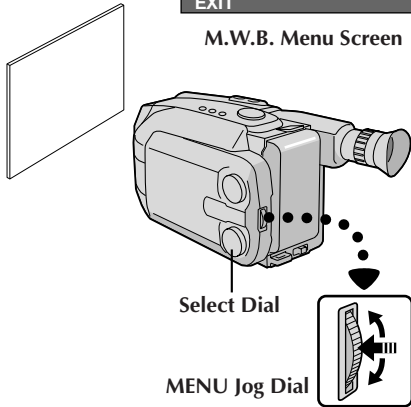

Manual White Balance Adjustment (M.W.B.)

The white balance is usually adjusted automatically. However, the more advanced camcorder operator would prefer to control this function manually and achieve a more professional colour/tint reproduction.

ACCESS MENU SCREEN

- 1 Turn the Select Dial to any position except AUTO LOCK, then press the MENU Jog Dial. The Menu Screen appears.

ACCESS WHITE BALANCE MENU SCREEN

- 2 Rotate the MENU Jog Dial to move the highlight bar to "M.W.B.", then press it.

SELECT WHITE BALANCE

- 3 Rotate the MENU Jog Dial to move the highlight bar to the required white balance.

"AUTO"	Automatic adjustment
"☀" : FINE"	Outdoors on sunny day
"☁" : CLOUD"	Outdoors on cloudy day
"☀" : HALOGEN" ...	Light source is halogen or tungsten lamp
"MWB"	When using a personal White Balance Setting stored in memory (see below.)

CLOSE MENU

- 4 Press the MENU Jog Dial. The Menu Screen reappears. Then press the MENU Jog Dial again to exit the Menu Screen.

MWB

MWB sets the colour temperature for the subject's light source so you can shoot with natural colours that are unaffected by surroundings, even when there are multiple subjects with different colour temperatures.

PREPARE WHITE OBJECT

- 1 Point the camcorder at a white, flat object such as a sheet of white paper.

SELECT MWB

- 2 Follow step 1 through 3 of the above, select "MWB".

MEMORIZE WHITE BALANCE

- 3 Press the MENU Jog Dial until "MWB" begins blinking. "MWB" blinks while the white balance is being stored in memory, then the Menu Screen reappears when memorization is complete.

CLOSE MENU

- 4 Press the MENU Jog Dial.

NOTES:

- To switch to automatic white balance adjustment, set the M.W.B. in the Menu Screen to "AUTO", or turn the Select Dial to "AUTO LOCK".
- Re-adjust the White Balance when the lighting has changed, when the camcorder has been turned off and on again, or when the Select Dial's position has been changed.
- When adjusted by putting coloured paper in front of the subject in step 1 of "MWB", this unit makes its colour temperature standard for automatic white balance. So you can enjoy shooting with different colours. For example, when adjusting with red, blue or yellow colours, the image becomes the colour which approximates to green, orange or purple respectively.

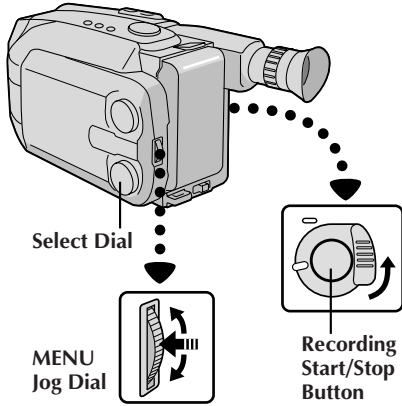

LCD monitor or viewfinder

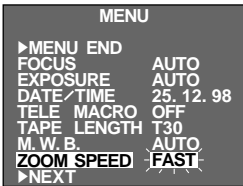

Menu Screen

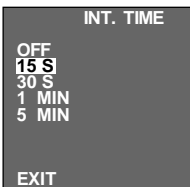
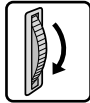
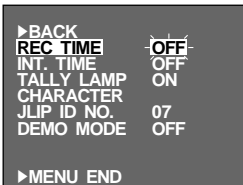

INT. TIME Menu

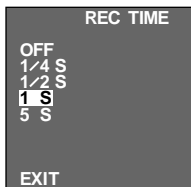

REC TIME Menu

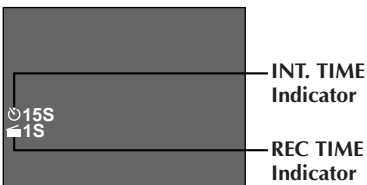

INT. TIME and REC TIME indications on the normal screen

Self-Timer

You can set the delay between pressing the Recording Start/Stop Button and the actual start of recording. If you secure the camcorder, you (or whomever is operating the camcorder) can enter the scene before recording starts.

NOTE:

Make sure the camcorder is in the Record-Standby mode before performing the following steps.

ACCESS MENU SCREEN

- 1 Turn the Select Dial to any position except AUTO LOCK, then press the MENU Jog Dial.

ACCESS INT. TIME MENU SCREEN

- 2 Rotate the MENU Jog Dial to move the highlight bar to "INT. TIME", then press the MENU Jog Dial.

SET INTERVAL TIME

- 3 Rotate the MENU Jog Dial to move the highlight bar to the desired time, then press the MENU Jog Dial. The Menu Screen reappears and the highlight bar is placed on "MENU END".

CLOSE MENU

- 4 Press the MENU Jog Dial.

START DELAYED RECORDING

- 5 Press the Recording Start/Stop Button. When the selected time has elapsed, recording begins automatically.

To Cancel Self-Timer . . .

... Before the recording begins, press the Recording Start/Stop Button to display "≡PAUSE≡", then set "INT. TIME" in the Menu Screen to "OFF".

Animation

Give stationary scenes or objects an illusion of movement. This function allows you to shoot a series of pictures, each slightly different, of the same object for a brief period of time.

NOTE:

Make sure the camcorder is in the Record-Standby mode and the recording mode is set to "SP" before performing the following steps.

ACCESS MENU SCREEN

- 1 Turn the Select Dial to any position except AUTO LOCK, then press MENU Jog Dial.

SET RECORDING TIME

- 2 Rotate the MENU Jog Dial to move the highlight bar to "REC TIME", then press the MENU Jog Dial. The REC TIME Menu appears. Rotate the MENU Jog Dial to move the highlight bar to the desired time, then press the MENU Jog Dial. The Menu Screen reappears. Press the MENU Jog Dial again to exit the Menu Screen.

START RECORDING

- 3 Press the Recording Start/Stop Button after focusing on the subject. The recording stops automatically after the selected period of time.

ASSEMBLE SERIES OF PICTURES

- 4 Repeat step 3 for the desired number of pictures.

RELEASE ANIMATION MODE

- 5 Set "REC TIME" in the Menu screen to "OFF".

NOTES:

- For best results, make sure the camcorder is secured when shooting in Animation or Time-Lapse mode.
- Fade-in/out cannot be performed during Animation or Time-Lapse shooting.
- Before performing other operations following Animation or Time-Lapse recording, make sure the Animation or Time-Lapse mode is deactivated.
- Self-Timer, Animation and Time-Lapse are cancelled when the power is shut off or when the cassette is ejected.

Time-Lapse

You can record sequentially at preset time spans. Leaving the camcorder aimed at a specific subject, you can record subtle changes over an extended period of time.

NOTE:

Make sure the camcorder is in the Record-Standby mode and the recording mode is set to "SP" before performing the following steps.

ACCESS MENU SCREEN

- 1 Turn the Select Dial to any position except AUTO LOCK, then press MENU Jog Dial.

SET INTERVAL BETWEEN RECORDINGS

- 2 Rotate the MENU Jog Dial to move the highlight bar to "INT. TIME", then press the MENU Jog Dial. The INT. TIME Menu appears. Rotate the MENU Jog Dial to move the highlight bar to the desired time, then press the MENU Jog Dial. The Menu Screen reappears.

SET RECORDING TIME

- 3 Rotate the MENU Jog Dial to move the highlight bar to "REC TIME", then press the MENU Jog Dial. The REC TIME Menu appears. Rotate the MENU Jog Dial to move the highlight bar to the desired time, then press the MENU Jog Dial. The Menu Screen reappears. Press the MENU Jog Dial again to exit the Menu Screen.

START TIME-LAPSE RECORDING

- 4 Press the Recording Start/Stop Button. Recording and intervals alternate automatically.

RELEASE TIME-LAPSE MODE

- 5 To release when "≡PAUSE≡" is displayed, set "REC TIME" and "INT. TIME" in the Menu Screen to "OFF". To release when "≡PAUSE≡" and "▶▶▶" are not displayed, press the Recording Start/Stop Button to display "≡PAUSE≡", then set "REC TIME" and "INT. TIME" in the Menu Screen to "OFF".

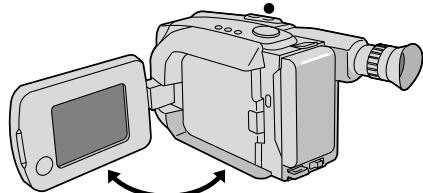
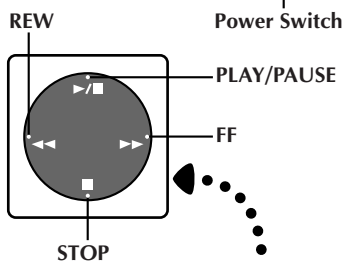
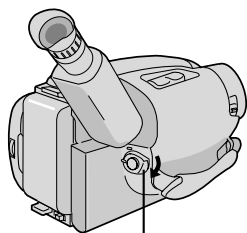

LCD Monitor in Retracted Position

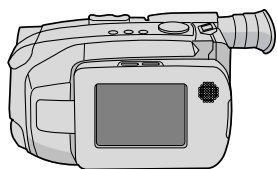

Battery pack remaining power indicator

Tape counter

Recording mode indicator

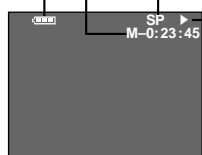

Tape running indicator

- ▶ : Playback
- ▶▶ : Fast-Forward/
Forward Search
- ◀◀ : Rewind/Reverse
Search
- : Still Playback

LCD monitor/
viewfinder
indications

LOAD A CASSETTE

- 1 First open the LCD monitor to an angle of over 45 degrees. Press **EJECT** to open the cassette holder, then insert the cassette with the label facing out. Press **PUSH** to ensure the holder is closed and locked.

SELECT MODE

- 2 Make sure the LCD monitor is fully open. Then set the Power Switch to "PLAY". The power indicator lights.

PLAY BACK

- 3 Press **PLAY/PAUSE**. The playback picture appears.

STOP PLAYBACK

- 4 Press **STOP**.

Rewind or Fast-forward the tape

Press **REW** to rewind, or **FF** to fast-forward the tape during Stop mode.

NOTES:

- The camcorder shuts off automatically after about 5 minutes in Stop mode. To turn on again, set the Power Switch to "POWER OFF", then to "PLAY".
- When the Power Switch is set to "PLAY" and the LCD monitor is opened at an angle of 45 degrees or more, the LCD monitor switches on and the viewfinder switches off automatically to save power.
- The playback picture can also be viewed in the viewfinder (with the LCD monitor shut) or on a connected TV (pg. 40). Camcorder operation is the same as described in this section.
- You can also view the playback picture on the LCD monitor with it flipped over and retracted.
- LCD monitor/viewfinder indications:
 - The battery pack remaining power indicator is displayed for approx. 5 seconds on the LCD monitor when the LCD monitor is turned on, and then it disappears. However, the battery pack remaining power indicator "☐" blinks when the power is almost gone.
 - During Stop, Fast-Forward or Rewind mode, none of the indications are displayed in the viewfinder.

Adjust the brightness of the LCD monitor

To brighten the image, turn the **BRIGHT** Dial towards “+”. To darken the image, turn the Dial towards “-”.

Speaker volume control

You can adjust the speaker volume by turning the **VOLUME** Dial.

ADJUST VOLUME

- 1 **If you want to turn up the volume . . .**
Turn the Dial towards “+”.
- If you want to turn down the volume . . .**
Turn the Dial towards “-”.

NOTE:

When the LCD monitor is turned off, sound is not heard from the speaker.

Tracking

This function can be used to eliminate noise bars that appear on-screen during playback. Initial setting is Auto Tracking. Manual Tracking is also available.

ACTIVATE MANUAL TRACKING

- 1 Press the MENU Jog Dial during playback mode. Keep rotating it until noise bars disappear.

- To return to Auto Tracking, press the MENU Jog Dial. “AT” blinks. When Auto Tracking finishes, the indication disappears.

NOTES:

- When noise bars appear during playback, the camcorder enters the Auto Tracking mode and “AT” is displayed.
- Manual Tracking may not work with tapes recorded on other VCRs or camcorders.

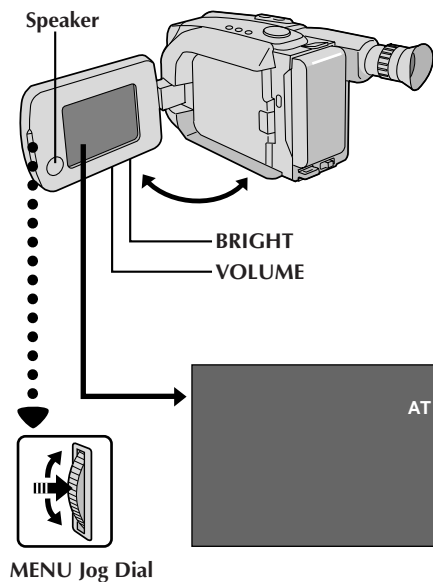

MENU Jog Dial

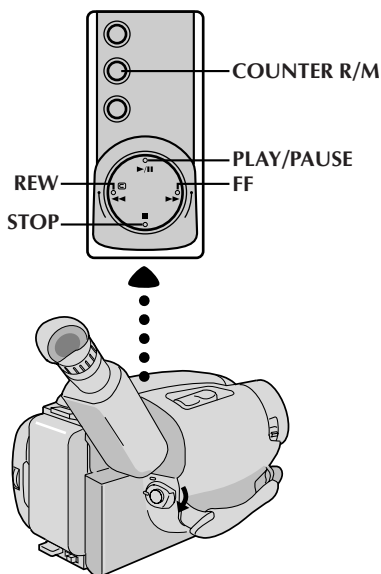

<p>FEATURE:</p> <p>PURPOSE:</p> <p>OPERATION:</p> <p>NOTE:</p>	<p>Still Playback</p> <p>To pause during playback.</p> <ol style="list-style-type: none"> 1) Press PLAY/PAUSE during playback. 2) To resume normal playback, press PLAY/PAUSE again. <p><i>Noise bars appear and pictures may become monochrome during Still Playback. This is normal.</i></p>
<p>FEATURE:</p> <p>PURPOSE:</p> <p>OPERATION:</p> <p>NOTE:</p>	<p>Shuttle Search</p> <p>To allow high-speed search in either direction.</p> <p>Forward Search</p> <ol style="list-style-type: none"> 1) Press FF during playback. <p>Reverse Search</p> <ol style="list-style-type: none"> 1) Press REW during playback. <p><i>Noise bars appear and pictures may become monochrome or darken in Shuttle Search. This is normal.</i></p>
<p>FEATURE:</p> <p>PURPOSE:</p> <p>OPERATION:</p> <p>NOTES:</p>	<p>Counter Memory Function</p> <p>To make it easier to locate a specific tape segment.</p> <ol style="list-style-type: none"> 1) Press COUNTER R/M and hold for more than 1 second. The counter resets to "0:00:00". 2) Press COUNTER R/M for less than 1 second. "M" appears. 3) After recording or playback, press STOP, then REW. The tape automatically stops at or close to 0:00:00. 4) Press PLAY/PAUSE to start playback. <ul style="list-style-type: none"> • <i>The counter memory functions in the Fast-Forward and Rewind modes.</i> • <i>To disable Counter Memory Function, press COUNTER R/M for less than 1 second so the "M" disappears.</i>

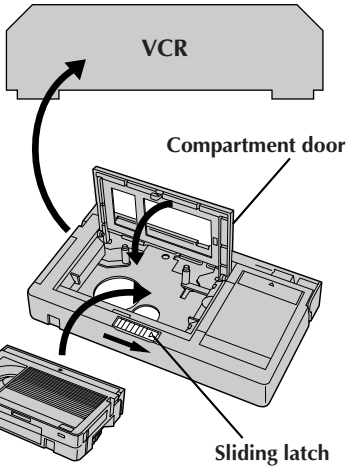
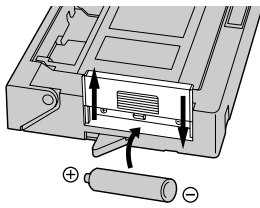

Compact video cassette

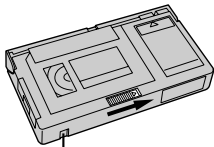

Recording safety hole

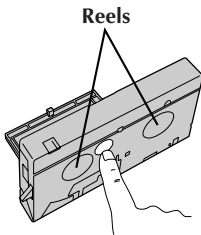

Reels

Cassette Adapter

Use this to play back a VHS-C video cassette recorded with this camcorder. It is fully compatible with any VHS video cassette recorder. The C-P7U adapter is battery powered and automatically performs tape loading and unloading.

1 INSERT BATTERY

Slide the battery cover up to remove it, and install one "R6(AA)" size battery as shown in the illustration to the left. Then reattach the cover.

2 INSERT CASSETTE IN ADAPTER

Slide the latch to open the adapter compartment door, then insert the cassette and close the compartment door.

3 PLAY BACK ON CONNECTED VCR

Load the cassette adapter into the VCR and play the tape back as you would any other.

4 REMOVE CASSETTE FROM ADAPTER

Slide the latch and the compartment door opens automatically. This may take around 10 seconds. Do not attempt to force the adapter open. Then insert your finger in the hole on the underside of the adapter as shown in the illustration to the left, push up and remove the cassette.

NOTES:

- During tape loading and unloading, do not touch the reels for safety and tape protection.
- During special-effect playback (slow motion, still frame, etc.), the picture may vibrate or noise bars may appear on the screen.
- To record on a VCR using a compact cassette and the adapter, cover the adapter's recording safety hole with adhesive tape.

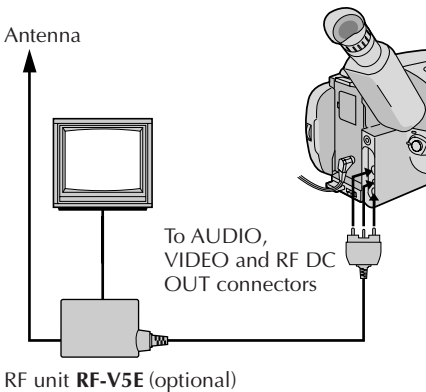
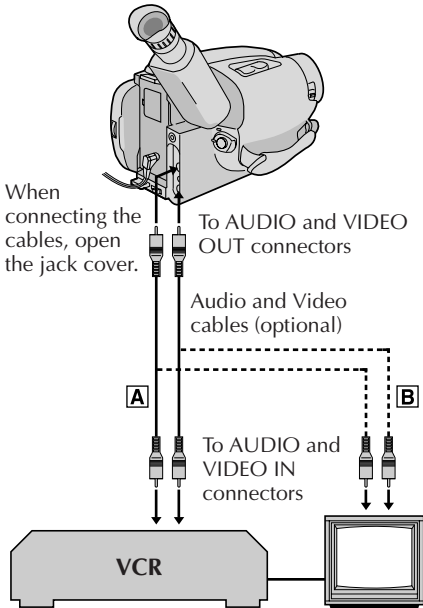
**NOTES:**

- It is recommended to use the AC Power Adapter/Charger as the power supply instead of the battery pack.
- To monitor the picture and sound from the camcorder without inserting a tape, set the camcorder's Power Switch to "CAMERA", then set your TV to the appropriate input mode.
- If you have a TV or speakers that are not specially shielded, do not place the speakers adjacent to the TV as interference will occur in the camcorder playback picture.

There are three basic types of connections. When making the connections, refer also to your VCR and TV instruction manuals.

Connection To A VCR **A** (Editing, Dubbing and Playback)

NOTE:

Use the optional Audio and Video cables.

CONNECT CAMCORDER TO VCR

- 1 As shown in the illustration to the left, connect the Audio and Video cables between the AUDIO and VIDEO OUT connectors on the camcorder and those on the VCR.

SUPPLY POWER

- 2 Turn on the camcorder, the VCR and the TV.

SELECT MODE

- 3 Set the VCR to its AUX input mode, and set the TV to its VIDEO mode.

Connection To A TV With A/V Input Connectors **B** (Playback ONLY)

NOTE:

Use the optional Audio and Video cables.

CONNECT CAMCORDER TO TV

- 1 As shown in the illustration to the left, connect the Audio and Video cables between the AUDIO and VIDEO OUT connectors on the camcorder and those on the TV.

SELECT MODE

- 2 Set the TV to its VIDEO or AV mode (as specified in its instructions).

Connection To A TV With NO A/V Input Connectors (Playback ONLY)

NOTE:

Use the optional RF-V5E RF unit.

*Refer to the RF-V5E instruction manual for connection procedure.

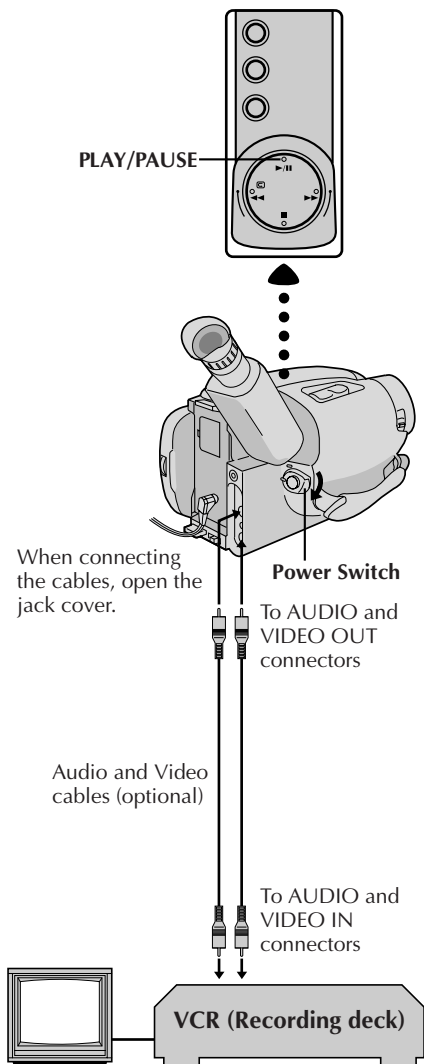

Tape Dubbing

CONNECT EQUIPMENT

- 1 Following the illustration to the left, connect the camcorder and the VCR.

PREPARE FOR DUBBING

- 2 Set the camcorder's Power Switch to "PLAY", turn on the VCR's power, and insert the appropriate cassettes in the camcorder and the VCR.

SELECT VCR MODE

- 3 Engage the VCR's AUX and Record-Pause modes.

FIND EDIT-IN POINT

- 4 Engage the camcorder's Play mode to find a spot just before the edit-in point. Once it's reached, press **PAUSE** on the camcorder.

START EDITING

- 5 Press **PLAY** on the camcorder and engage the VCR's Record mode.

STOP EDITING TEMPORARILY

- 6 Engage the VCR's Record-Pause mode and press **PAUSE** on the camcorder.

EDIT MORE SEGMENTS

- 7 Repeat steps 4 through 6 for additional editing, then stop the VCR and camcorder when finished.

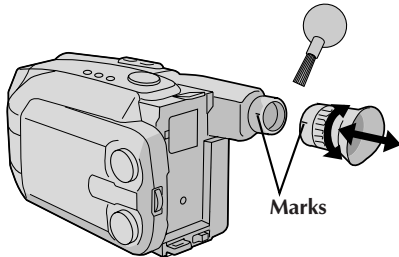
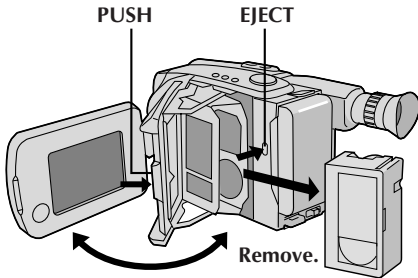
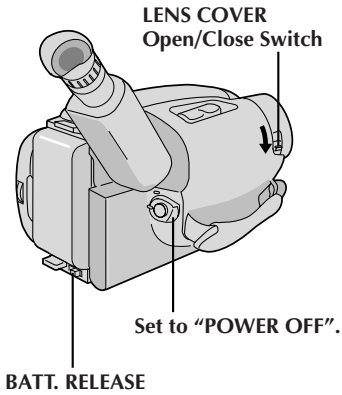

After Use

- 1 Set the Power Switch to "POWER OFF" to turn off the camcorder.
- 2 Press **EJECT** to open the cassette holder, then remove the cassette.
- 3 Close and lock the cassette holder by pressing **PUSH**.
- 4 Close and lock the LCD monitor.
- 5 Slide **BATT. RELEASE** to remove the battery pack.
- 6 Slide the **LENS COVER** open/close switch to close the lens cover.

Cleaning The Camcorder

- 1 **CLEAN EXTERIOR**
Wipe gently with a soft cloth.
- 2 **CLEAN LCD MONITOR**
Open the LCD monitor and wipe gently with soft cloth. Be careful not to damage the monitor. Close the LCD monitor.
- 3 **CLEAN LENS**
Blow it with a blower brush, then wipe gently with lens cleaning paper.
- 4 **REMOVE EYEPIECE**
Turn the eyepiece counterclockwise and pull it out.
- 5 **CLEAN VIEWFINDER**
Remove dust using a blower brush.
- 6 **RE-ATTACH EYEPIECE**
Align the marks, re-attach the eyepiece and turn it clockwise.

NOTES:

- Avoid using strong cleaning agents such as benzine or alcohol.
- Cleaning should be done only after the battery pack has been removed or other power units have been disconnected.
- Mould may form if the lens is left dirty.

SYMPTOM	POSSIBLE CAUSE(S)
POWER	
No power is supplied.	<ul style="list-style-type: none"> ● The battery pack has not been attached correctly (☞ pg. 6). ● The battery pack is not charged (☞ pg. 6). ● The power supply has not been correctly connected (☞ pg. 7).
The power suddenly goes off and doesn't come back on by itself.	<ul style="list-style-type: none"> ● The battery pack has completely discharged. ● Remove the cassette and disconnect the power source, then after a few minutes, try turning the power back on. If it still doesn't come on, consult your nearest JVC dealer.
RECORDING	
Recording cannot be performed.	<ul style="list-style-type: none"> ● Make sure the Erase Protection tab is in the position that allows recording. If not, slide the tab. Some cassettes have removable tabs. If the tab has been removed, cover the hole with adhesive tape.
Recording does not start.	<ul style="list-style-type: none"> ● The camcorder Power Switch has not been set to "CAMERA" (☞ pg. 14).
PLAYBACK	
The tape is running, but there's no playback picture.	<ul style="list-style-type: none"> ● The TV has not been set to its VIDEO mode. ● If A/V connection is used, the TV's VIDEO/TV Switch has not been set to VIDEO. ● The RF unit has not been set to the correct channel.
Playback picture is blurred or interrupted.	<ul style="list-style-type: none"> ● The video heads are dirty or worn out. Consult your nearest JVC dealer for head cleaning or replacement.
The counter indication is blurred during Still playback.	<ul style="list-style-type: none"> ● This is normal.
TAPE TRANSPORT	
The tape stops during fast-forward or rewind.	<ul style="list-style-type: none"> ● The Counter Memory Function has been activated (☞ pg. 38).
Rewinding or fast-forwarding cannot be performed.	<ul style="list-style-type: none"> ● The tape is already fully wound on one reel or the other.

SYMPTOM	POSSIBLE CAUSE(S)
OTHER	
The tape won't eject.	<ul style="list-style-type: none"> ● The battery pack is running low. ● If the LCD monitor is not open over 45 degrees, EJECT switch does not function.
Some functions are not available.	<ul style="list-style-type: none"> ● The Select Dial is set to "AUTO LOCK".
Vertical white lines appear when shooting a very bright object.	<ul style="list-style-type: none"> ● This sometimes occurs when the contrast between the background and the object is great. It is not a defect of the camcorder.
Bright, crystal-shaped spots appear in the LCD monitor and the viewfinder.	<ul style="list-style-type: none"> ● Sunlight is directly entering the lens. This is not a defect of the camcorder.
The rear of the LCD monitor is hot.	<ul style="list-style-type: none"> ● The light used to illuminate the LCD monitor causes it to be hot. Close the LCD monitor to turn it off or set the Power Switch to OFF, and let the unit cool down.
Coloured bright spots appear all over the LCD monitor.	<ul style="list-style-type: none"> ● The LCD monitor is made with high-precision technology. However, black spots or bright spots of light (red, green or blue) may appear constantly on the LCD monitor. These spots are not recorded on the tape. This is not due to any defect of the unit. (Effective dots: more than 99.99 %.)
The indicators and the picture colour on the LCD monitor are not clear.	<ul style="list-style-type: none"> ● This may occur when the surface or the edge of the LCD monitor is pressed.
The LCD monitor, the viewfinder and the lens have become dirty (ex. fingerprints).	<ul style="list-style-type: none"> ● Wipe them gently with soft cloth. Gently wipe the LCD monitor in a semicircle because wiping strongly spreads the stain and it won't come out easily.
The picture is blurred in the Quick Review or Retake mode.	<ul style="list-style-type: none"> ● This is normal while recording in the LP mode. Some noise may be present while recording in the SP mode (☞ pg. 10).
An error number (i.e. E03) appears.	<ul style="list-style-type: none"> ● Turn the camcorder's power off, then disconnect the power source. After a few minutes, try turning the power on again. If the error number still appears, consult your nearest JVC dealer.
The image is out of focus.	<ul style="list-style-type: none"> ● The dioptre needs to be adjusted (☞ pg. 12). ● The scene being shot is adversely affecting the operation of Auto Focus (☞ pg. 30).
The date and time displays disappear.	<ul style="list-style-type: none"> ● If you remove the power source from the camcorder while the power is on, all settings and selections are erased. Make sure to turn the camcorder's power off before disconnecting the power source.
The wrong date and time are displayed/recorded.	<ul style="list-style-type: none"> ● If you have not performed Date/Time Setting (☞ pg. 9), the date and time are not displayed/recorded correctly. Be sure that Date/Time setting is carried out.
Even though the Lens Cover is open, the Lens Cover Warning indicator blinks.	<ul style="list-style-type: none"> ● The Lens Cover Warning indicator may blink when the camcorder is used in dark areas, regardless of the position of the Lens Cover.

The camcorder is a microcomputer-controlled device. External noise and interference (from a TV, a radio, etc.) might prevent it from functioning properly. In such cases, first disconnect its power supply unit (battery pack, AC Power Adapter/Battery Charger, etc.) and clock battery; and then re-connect it and proceed as usual from the beginning.

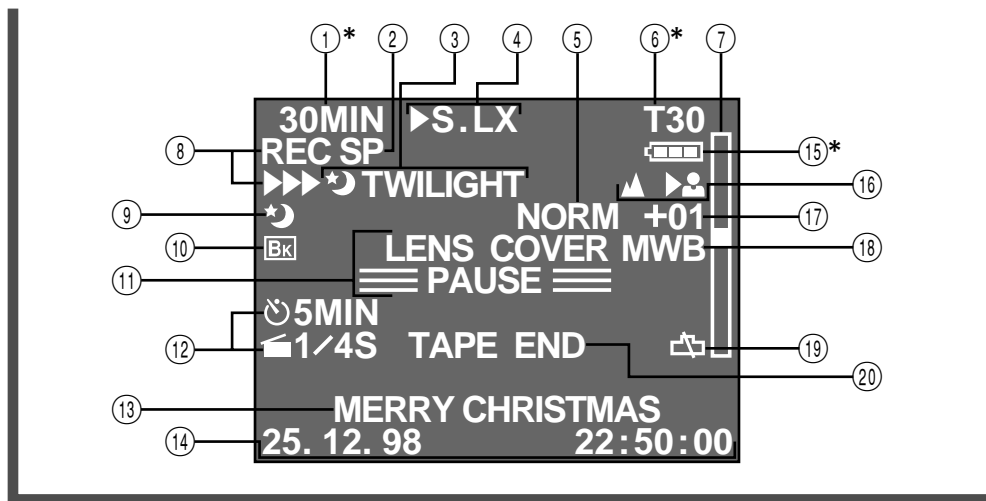

LCD monitor/Viewfinder Indications







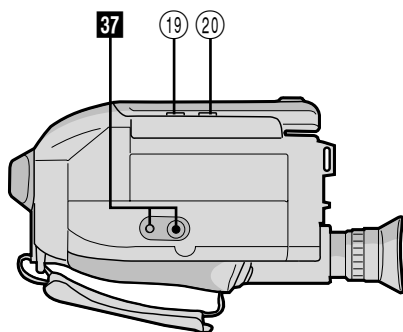
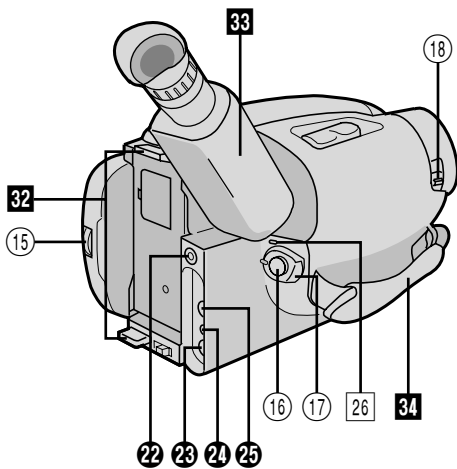
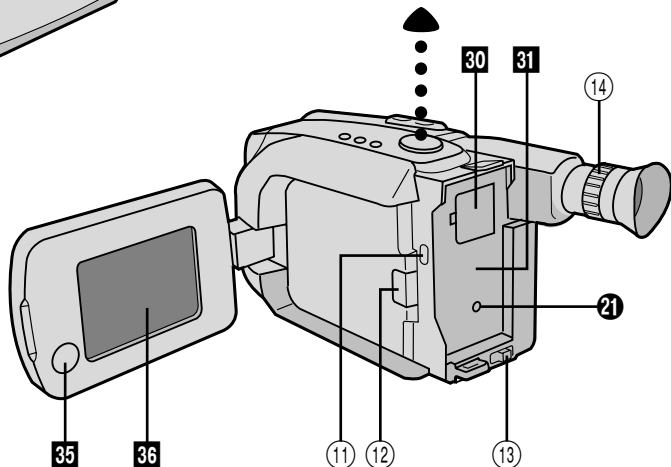
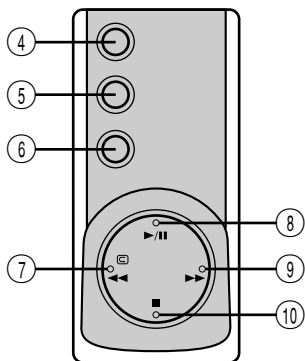
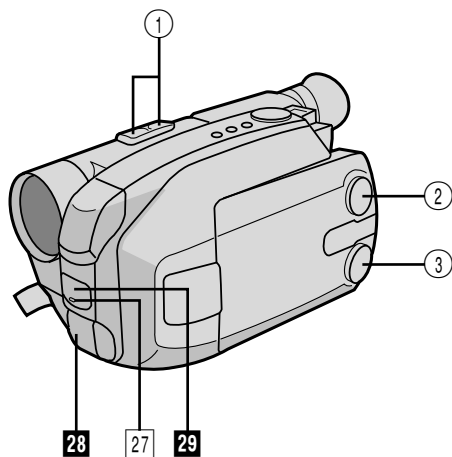



















- ① *Cassette Warning/
Tape Remaining Time pg. 15
When no cassette is inserted: the cassette (📀) warning blinks.
When Erase Protection tab is not in the position that allows recording: the cassette (📀) warning lights. Otherwise, the tape remaining time is displayed and the **tape remaining time warning†** blinks when the tape is about to reach its end.
When the Power Switch is set to “PLAY” and a tape is loaded: the cassette (📀) mark is displayed regardless of the Erase Protection tab’s position.
- ② Recording Mode (SP/LP) Indicator pg. 10
- ③, ⑨ Programme AE Indicator pg. 22
Displayed at ③ for approx. 1 second when the Select Dial is switched from one position to another. Then only the indicator remains at ⑨.
- ③, ⑩ Fade-Standby Indicator pg. 24
Displayed at ③ for approx. 2 seconds when the Fader is engaged by pressing the EFFECT button. Then only the indicator remains at ⑩.
- ④ Multi-Function Control Indication pg. 24
Displayed when any of the buttons located on the Multi-Function Control is pressed. The indication disappears within approx. 2 seconds.
- ⑤ Super LoLux Indicator pg. 25
- ⑥ *Tape Length Indicator pg. 10
- ⑦ Zoom Indicator Bar pg. 18
- ⑧ Recording Indicator pg. 14
- ⑪ • Record-Standby Mode Indicator pg. 14
• Lens Cover Warning:
LENS COVER pg. 15
- ⑫ Interval Timer/Recording Time/
5Sec. Rec Mode Indicator pgs. 20 ,34

- ⑬ Instant Title Display pg. 25
- ⑭ Date/Time/Character Display pg. 21
- ⑮ *Battery Pack Remaining Power Indicator
Changes as follows according to the battery pack’s remaining power level:
“”. When the power is almost gone, the indicator “” blinks (**battery power warning†**), then the unit shuts off. Replace the battery pack with a fully charged one.
Note: The symbol containing 3 darkened squares — — does not necessarily mean that the battery pack is fully charged.
- ⑯ Focus Indicator pg. 31
- ⑰ Exposure Control Level Counter pg. 32
- ⑱ White Balance Mode Indicator pg. 33
- ⑲ Clock Battery Warning
Blinks for approx. 10 seconds when the power is turned on. This display also blinks when the clock (lithium) battery is either not installed or has discharged. Install or replace the old battery with a new one (pg. 8).
- ⑳ • Tape End Display: TAPE END pg. 15
Appears when the end of the tape is reached during playback, recording or fast-forward.
• Condensation Warning:
When this indication appears, all functions except tape eject and power on/off are disabled. Turn the unit off (without removing the power source) for a few hours, and when you turn it on again the indication should disappear.





*: Displayed for approx. 5 seconds on the LCD monitor when the LCD monitor is turned on, and then disappears. However, the indications marked † are not displayed.





Controls

- ① Power Zoom Button  pg. 18
- ② Multi-Function Control
 - EFFECT Button  pg. 24
 - WIDE Button  pg. 24
 - TITLE Button  pg. 25
 - SUPER LOLUX Button  pg. 25
- ③ Select Dial  pg. 22
- ④ Recording Mode [SP/LP] Button  pg. 10
- ⑤ DATE/TIME Button  pg. 21
COUNTER R/M Button  pg. 38
- ⑥ 5SEC. REC [5-sec recording] Button ...  pg. 20
- ⑦ REW Button  pg. 36
RETAKE R [Quick Review] Button  pg. 19
- ⑧ PLAY/PAUSE Button  pg. 36
- ⑨ FF Button  pg. 36
RETAKE F Button  pg. 19
- ⑩ STOP Button  pg. 36
- ⑪ EJECT Switch  pg. 11
- ⑫ PUSH Button  pg. 11
- ⑬ BATT. [Battery] RELEASE Switch  pg. 6
- ⑭ Dioptre Adjustment  pg. 12
- ⑮ Function Navigator Dial
[MENU Jog Dial]  pg. 9
- ⑯ Recording Start/Stop Button  pg. 14
- ⑰ Power Switch  pg. 14, 36
- ⑱ LENS COVER Switch  pg. 14
- ⑲ BRIGHT Dial  pg. 37
- ⑳ VOLUME Dial  pg. 37









Connectors

- ㉑ DC IN Jack  pg. 7
- The jacks ㉒ to ㉔ are located beneath the jack cover.
- ㉒ J terminal [JLIP (Joint Level Interface Protocol) Connector]
 - It is used to connect the camcorder to a device such as a personal computer.
For further details consult your nearest JVC dealer.
 - JLIP-controlled editing from camcorder to VCR is not possible if the VCR is not equipped with a J terminal.
 - ㉓ VIDEO OUT Connector  pg. 40
 - ㉔ RF DC OUT Connector  pg. 40
 - ㉔ AUDIO OUT Connector  pg. 40

Indicators

- ㉔ Power Indicator  pg. 14
- ㉔ Tally Lamp  pg. 14

Other Parts

- ㉔ Microphone
- ㉔ Camera sensor
Be careful not to cover this area; built-in here is the sensor necessary for shooting.
- ㉔ Clock Battery Compartment  pg. 8
- ㉔ Battery Pack Mount  pg. 6
- ㉔ Shoulder Strap Eyelets  pg. 13
- ㉔ Electronic Viewfinder  pg. 12
- ㉔ Grip Strap  pg. 12
- ㉔ Speaker  pg. 37
- ㉔ LCD monitor  pg. 16, 36
- ㉔ Tripod Mounting Socket  pg. 13

A

AC Power Adapter	pg. 6
Animation Recording	pg. 35
Auto Date Record	pg. 21
Auto Focus	pg. 30
Auto Mode Lock Mode	pg. 23
Auto Mode Release Mode	pg. 23

B

Battery Pack	pg. 6, 49
Brighten the Image	pg. 32

C

Car Battery	pg. 7
Cassette Adapter	pg. 39
Charge Marker	pg. 7
Charging the Battery Pack	pg. 6
Clock (Lithium) Battery	pg. 8
Connection to a VCR/TV	pg. 40
Contents	cover page
Counter Memory	pg. 38

D

Darken the Image	pg. 32
Date/Time/Character Insert	pg. 21
Date/Time Setting	pg. 9
DEMO Mode	pg. 29
Discharge the Battery pack	pg. 6
Dioptr Adjust	pg. 12

E

Electronic Fog Filter Mode	pg. 23
Erase Protection	pg. 11
Exposure Control	pg. 32

F

Fade-in/out	pg. 24
Fast-Forward Tape	pg. 36
5Sec. Rec	pg. 20

G

Grip Adjustment	pg. 12
-----------------------	--------

H

High Speed Shutter Mode	pg. 23
-------------------------------	--------

I

Insert Cassette	pg. 11
Instant Titles	pg. 25
Interface Shooting	pg. 17

J

Journalistic shooting	pg. 17
-----------------------------	--------

L

LCD monitor/Viewfinder, indications	pg. 45
---	--------

M

Manual Focus	pg. 31
--------------------	--------

N

ND Effect Mode	pg. 23
----------------------	--------

P

Playback	pg. 36
Programme AE with Special Effects	pg. 22, 23
Provided Accessories	pg. 4

Q

Quick Review	pg. 19
--------------------	--------

R

Recording, Advanced Features	pg. 22–35
Recording	pg. 14
Recording, Start/Stop	pg. 14, 15
Recording Mode Setting	pg. 10
Record-Standby	pg. 14
Remove Cassette	pg. 11
Retake	pg. 19
Rewind Tape	pg. 36

S

Self-Timer	pg. 34
Sepia Mode	pg. 23
Shoulder Strap Attachment	pg. 13
Shuttle Search	pg. 38
Specifications	pg. 51
Sports Mode	pg. 23
Still Playback	pg. 38
Super LoLux	pg. 25

T

Tape Counter	pg. 36
Tape Dubbing	pg. 41
Tape Length Setting	pg. 10
Time-Lapse Shooting	pg. 35
Tracking	pg. 37
Tripod Mounting	pg. 13
Twilight Mode	pg. 23

V

Viewfinder Adjustment	pg. 12
-----------------------------	--------

W

White Balance Adjustment	pg. 33
Wide Mode	pg. 24

Z

Zooming	pg. 18
---------------	--------

General Battery Precautions

- When the C-P6U or C-P7U (cassette adapter) is not functioning even when correctly operated, the battery is exhausted. Replace it with a fresh one.
- Use only the following battery:
C-P6U or C-P7U AA (R6) size

Please make note of the following rules for battery use. When misused, battery can leak or explode.

1. Refer to the C-P6U/C-P7U instructions when replacing the battery.
2. **Do not** expose the battery to excessive heat as it can leak or explode.
3. **Do not** dispose of battery in a fire.
4. Remove battery from the unit if it is to be stored for an extended period to avoid battery leakage which can cause malfunctions.

Battery Packs

The supplied battery pack is a nickel-cadmium battery. Before using the supplied battery pack or an optional battery pack, be sure to read the following cautions:

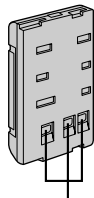

1. **To avoid hazard . . .**
 - do not burn.
 - **do not** short-circuit the terminals. **Terminals**
 - **do not** modify or disassemble.
 - use only specified chargers.
2. **To prevent damage and prolong service life . . .**
 - **do not** subject to unnecessary shock.
 - avoid repeated charging without fully discharging.
 - charge in an environment where temperatures are within the tolerances shown in the chart below. This is a chemical reaction type battery—cooler temperatures impede chemical reaction, while warmer temperatures can prevent complete charging.
 - store in a cool, dry place. Extended exposure to high temperatures will increase natural discharge and shorten service life.
 - avoid prolonged uncharged storage.
 - remove from charger or powered unit when not in use, as some machines use current even when switched off.

NOTES:

- *It is normal for the battery pack to be warm after charging, or after use.*
Temperature Range Specifications
Charging 10°C to 35°C
Operation 0°C to 40°C
Storage -10°C to 30°C
- *Recharging time is based on room temperature of 20°C.*
- *The lower the temperature, the longer recharging takes.*

Cassettes

To properly use and store your cassettes, be sure to read the following cautions:

1. **During use . . .**
 - make sure the cassette bears the VHS-C mark.
 - be aware that recording onto prerecorded tapes automatically erases the previously recorded video and audio signals.
 - make sure the cassette is positioned properly when inserting.
 - do not load and unload the cassette repeatedly without allowing the tape to run at all. This slackens the tape and can result in damage.
 - do not open the front tape cover. This exposes the tape to fingerprints and dust.
2. **Store cassettes . . .**
 - away from heaters or other heat sources.
 - out of direct sunlight.
 - where they won't be subject to unnecessary shock or vibration.
 - where they won't be exposed to strong magnetic fields (such as those generated by motors, transformers or magnets).
 - vertically, in their original cases.

Main Unit

1. **For safety, DO NOT . . .**
 - open the camcorder's chassis.
 - disassemble or modify the unit.
 - short-circuit the terminals of the battery pack. Keep it away from metallic objects when not in use.
 - allow inflammables, water or metallic objects to enter the unit.
 - remove the battery pack or disconnect the power supply while the power is on.
 - leave the battery pack attached when the camcorder is not in use.
2. **Avoid using the unit . . .**
 - in places subject to excessive humidity or dust.
 - in places subject to soot or steam such as near a cooking stove.
 - in places subject to excessive shock or vibration.
 - near a television set.
 - near appliances generating strong magnetic or electric fields (speakers, broadcasting antennas, etc.).
 - in places subject to extremely high (over 40°C) or extremely low (under 0°C) temperatures.

3. **DO NOT leave the unit . . .**
 - in places of over 50°C.
 - in places where humidity is extremely low. (below 35%) or extremely high (above 80%).
 - in direct sunlight.
 - in a closed car in summer.
 - near a heater.
4. **To protect the unit, DO NOT . . .**
 - allow it to become wet.
 - drop the unit or strike it against hard objects.
 - subject it to shock or excessive vibration during transportation.
 - keep the lens directed at extremely bright objects for long periods.
 - direct the eyepiece of the viewfinder at the sun.
 - carry it by holding the viewfinder or the LCD monitor. Be sure to hold the main unit with both hands or use the grip.
 - swing it excessively when using the shoulder strap.

LCD monitor

1. **To prevent damage to the LCD monitor, DO NOT . . .**
 - push it strongly or apply any shocks.
 - place the camcorder with the LCD monitor on the bottom.
2. **To prolong service life . . .**
 - avoid rubbing it with coarse cloth.
3. **Be aware of the following phenomena for LCD monitor use. These are not malfunctions . . .**
 - While using the camcorder, the surface around the LCD monitor and/or the back of the LCD monitor may heat up.
 - If you leave power on for a long time, the surface around the LCD monitor becomes hot.

About moisture condensation . . .

- You may have observed that pouring a cold liquid into a glass will cause drops of water to form on the glass' outer surface. This same phenomenon occurs on the head drum of a camcorder when it is moved from a cool place to a warm place, after heating a cold room, under extremely humid conditions or in a place directly subjected to the cool air from an air conditioner.
- Moisture on the head drum can cause severe damage to the video tape, and can lead to internal damage to the camcorder itself.

Serious malfunctioning

If malfunctioning occurs, stop using the unit immediately and consult your local JVC dealer.

SPECIAL NOTES ON VIDEO HEADS

Dust and dirt on video heads

1. Always allow enough time for your camcorder to acclimatize to its environment before using it.
2. Do not use the unit in areas of high humidity. (Typical areas of high humidity are given below.)
 - From being used or stored in a very cold outdoor situation, then immediately being used in a warm indoor situation.
 - From being used or stored in a cool air-conditioned situation, then being used in a high-humidity outdoor situation.
 - Other areas where rapid large temperature changes can occur.
3. Taking care of your "C" format video cassette tapes.
 - Store the video cassette tapes in a vertical position, complete in their cassette cases.
 - During transportation, always store cassettes in their cassette cases.
4. Check recorded information at regular intervals. If the camcorder is equipped with a quick review facility, use this facility to check whether the picture is clear or not. If the quick review or playback picture is not clear, then the video heads may be dirty.

NOTE:

As a maladjusted tracking control can give similar symptoms to dirty video heads, please check that the tracking control of the unit is in the centre position.

Cleaning the video heads

Accumulation of dirt and other particles on the video heads may cause the playback picture to become blurred or interrupted. Although this camcorder is equipped with a built-in head cleaner which automatically cleans the heads, reducing the likelihood of dirty heads, if such troubles are encountered, we recommend the use of the cleaning cassette specifically designed for JVC camcorders, model number TCC-2U. Please use the cleaning cassette as indicated below:



- ① After inserting the cleaning cassette, activate the Play mode for a maximum of 15 seconds (normally, 5 seconds is sufficient).
- ② Remove the cleaning cassette and check the playback picture with a previously good-recorded tape.
- ③ If the picture is clear, then recording on a new tape can begin when desired.
- ④ If the picture is not clear, repeat steps 1 to 3 up to two more times.
- ⑤ If the picture is still unclear, consult your local JVC dealer.

Important Note:

If heads have become dirty, the associated tape will also be damaged, please do not use the tape again.

- A built-in head cleaner automatically cleans the video heads and head drum whenever a cassette is loaded and unloaded to reduce head clogging.
- Cleaning cassette TCC-2U is available from your JVC local dealer.

GENERAL

Format	: VHS PAL standard
Power source	: DC 6V 
Power consumption	
LCD monitor off, viewfinder on	: 5.9 W
LCD monitor on, viewfinder off	: 6.1 W
LCD monitor on, viewfinder on	: 6.8 W
Signal system	: PAL-type
Video recording system	
Luminance	: FM recording
Colour	: Converted sub-carrier direct recording Conforms to VHS standard
Cassette	:  cassette
Tape speed	
SP	: 23.39 mm/sec.
LP	: 11.70 mm/sec.
Recording time (max.)	
SP	: 60 minutes
LP	: 120 minutes (with EC-60 cassette)
Operating temperature	: 0°C to +40°C
Operating humidity	: 35% to 80%
Storage temperature	: -20°C to +50°C
Weight	: Approx. 980 g
Dimensions	: 116 (W) x 117 (H) x 242 (D) mm

CAMERA

Pick up	: 1/4" format CCD
Lens	: F1.6, f = 3.8 to 83.6 mm, 22:1 power zoom lens with auto iris and macro control, filter diameter 46 mm
Viewfinder	: Electronic viewfinder with 0.5" black/white CRT
White balance adjustment	: Auto/Manual adjustment

LCD MONITOR

Size	: 3" diagonally measured
LCD system	: LCD/TFT active matrix system



VIDEO

Output	: 1 Vp-p, 75 ohms, unbalanced (via VIDEO OUT connector)
--------	---

AUDIO

Output	: -8 dBs, 1 k-ohm (via AUDIO OUT connector)
Speaker	: 20 mm round x 1, monaural

AC POWER ADAPTER/BATTERY CHARGER (AA-V15EA)

Power requirement	: AC 110 V to 240 V~, 50/60 Hz
Power consumption	: 23 W
Output	
Charge	: DC 8.5 V  , 1.3 A
VTR	: DC 6.3 V  , 1.8 A
Charging system	: Constant current, peak detection, timer controlled
Dimensions	: 140 (W) x 42 (H) x 68 (D) mm
Weight	: Approx. 300 g

CASSETTE ADAPTER (C-P7U)

Dimensions	: 188 (W) x 25 (H) x 104 (D) mm
Weight	: Approx. 240 g
Accessory	: "AA (R6)"-size battery x 1

Provided Accessories  **pg. 4**

Optional Accessories

- Battery Packs BN-V12U, BN-V22U, BN-V25U
- Car Battery Charger BH-V3E
- RF Unit RF-V5E
- Compact VHS-C Cassettes EC-60/45/30
- Active Carrying Bag CB-V7U

Some accessories are not available in some areas. Please consult your nearest JVC dealer for details on accessories and their availability.

Specifications shown are for SP mode unless otherwise indicated.

E. & O. E. Design and specifications subject to change without notice.

